

NFPA 99 Compliant Duplex Lubricated Rotary Vane Medical Vacuum Package 10 HP Base Mounted with Single Point Connection

Vacuum Package

- Fully compliant with the latest edition of NFPA 99
- Two lubricated rotary vane type vacuum pumps with inlet filter and isolation valve for each
- Two motors
- ASME coded vertical air receiver with bypass and manual drain
- Duplex control panel with automatic lead/lag controls
- All components completely pre-piped and pre-wired to single point service connections
- Vibration isolation mountings
- Liquid tight conduit, fittings and junction boxes for all control and power wiring
- All interconnecting piping and wiring is completed and operationally tested prior to shipment

Vacuum Pump

- Busch, lubricated rotary vane R 5 Series pump
- Three Non-metallic, non-asbestos vanes with minimum life of 30,000 hrs.
- Direct-driven through a shaft coupling
- Air-cooled
- End (ultimate) vacuum = 29.3" Hg (15 torr)
- Integral, fully recirculating oil supply
- Spin-on oil filter
- High discharge temperature switch
- Oil drain valve assembly with temperature gauge
- Uses Patton's SAE 30 weight oil
- Integral oil separation system with three stage oil and smoke eliminators capable of removing 99.9+% of particles from the exhaust gas stream
- Built-in, anti-suck-back valve mounted at the pump inlet
- 2 micron inlet filter for removal of particulates
- Shipped with initial charge of pump fluid

Vacuum Motor

- NEMA rated
- C-face
- TEFC
- 208 or 230/460V 3-phase

Intake Piping

- Vacuum pumps are connected to a common manifold and piped to a vertical receiver
- Inlet check valve on each pump
- Inlet isolation valve on each pump
- Flexible connectors between pumps and receiver
- Flexible connectors for inlet and discharge connections

Vacuum Receiver

- Vertical orientation with integrally mounted bypass and manual drain
- ASME Code stamped
- National Board Certified
- Rated for a minimum 200 PSIG design pressure
- Vacuum gauge
- Manual drain

Control System

- Mounted and wired duplex control system
- NEMA 12 and U.L. labeled
- HMI (Human Machine Interface) – touch screen display
 - + vacuum display
 - + runtime display
 - + alarm history display
 - + maintenance schedule and history display
 - + service indicator
 - + replacement parts display
 - + battery backup for history display
- Automatic lead/lag sequencing
- Circuit breaker disconnects for each motor with external operators
- Full voltage motor starters with overload protection
- 120V control circuit transformers for each motor circuit
- Visual and audible reserve unit alarm with isolated contacts for remote alarm
- Hand-off-auto selector switches
- Automatic alternation of all vacuum pumps based on a first-on/first-off principle with provisions for simultaneous operation if required
- Automatic activation of reserve unit if required
- Visual and audible alarm indication for high discharge temperature shutdown with isolated contacts for remote alarm

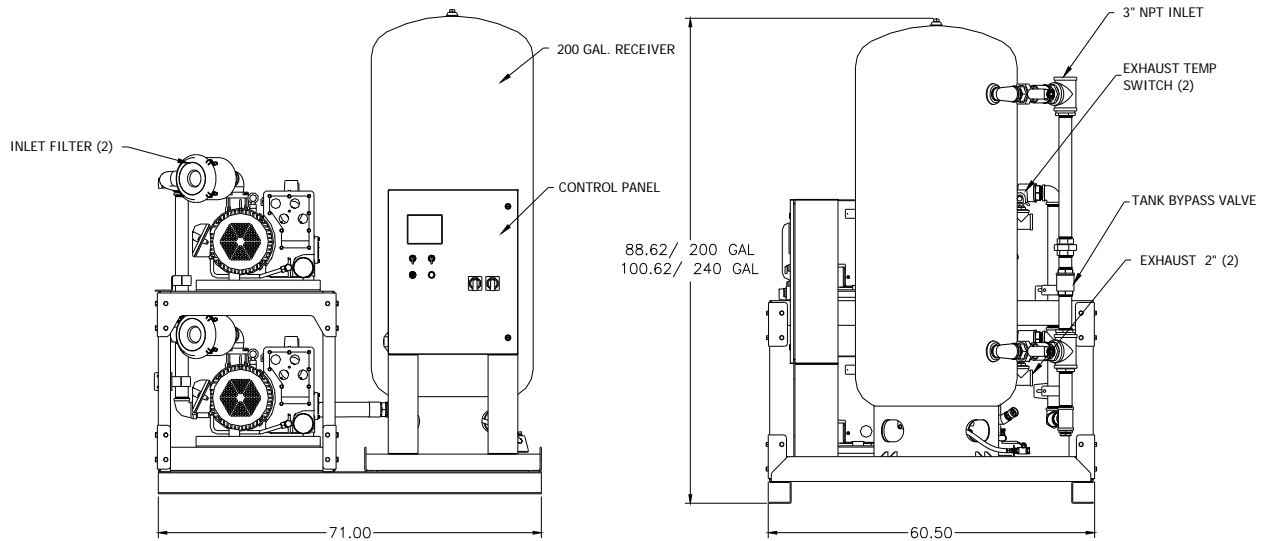
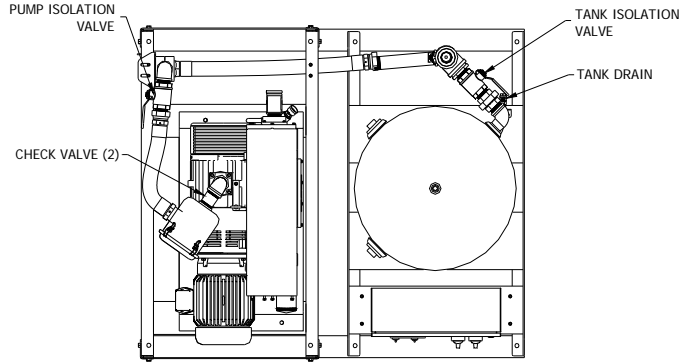

FOR COMPLETE GENERAL ASSEMBLY DIAGRAM (#101-04-063) CONTACT PATTON'S MEDICAL

Duplex Lubricated Rotary Vane Medical Vacuum Package Specifications ¹								
System Model No.	HP	Capacity @19" Hg ²		Receiver Gal.	System FLA			Package Weight
		Pump (SCFM)	System (SCFM)		208V	230V	460V	
72-23-104A	10	77	77	200	55			2348
72-23-105A				240				2364
72-23-104B				200	53		2348	
72-23-105B				240			2364	
72-23-104C				200		27	2348	
72-23-105C				240			2364	

Notes:

¹ Normal Operating conditions at a maximum ambient of 105° F. Consult factory for higher ambient conditions.

² Capacities are shown as NFPA system capacities (reserve vacuum pump on standby).

Statement of Warranty

Patton's Medical warrants all Medical Vacuum packages, to be free of defects in material and workmanship under normal use for a period not to exceed thirty (30) months from date of shipment, or twenty-four (24) months from date of start-up.