



rigid (stationary) lite ceiling column  
**approval booklet**



## Table of Contents

Product Description	3
Cleaning	3
Inspection and Testing	3
Elevation View	4
Device and Accessory Chart	5
Device Placement (Bottom View)	6
Electrical Diagram (Bottom View)	7
Mounting Plate to Outlet Detail	8
Mounting Information	9
Typical Location View	10

## Product Description

The Rigid-LITE Ceiling Column shall be an Amico Alert-1 series.

The shroud is made of 16 gauge stainless steel alloy #304 with a # 4 satin finish, consisting of a removable access panel, stainless steel ceiling collar and a heavy gauge steel mounting plate.

All electrical services are provided by means of EMT metal conduits and gas services are type L, oxygen cleaned copper pipes.

NOTE: Nitrogen is type K oxygen cleaned copper pipe.

Standard dimensions are 14 3/4" x 14 3/4."

NOTE: Electrical devices are pre-wired to electrical junction box at the mounting plate, unless other wise stated. Gases will be manifolded for single point connections to the source. All pipes will extend 8" from the top of mounting plate.

## Cleaning

The Amico Outlets are factory cleaned for oxygen service. Exposed surfaces of the outlet may be cleaned with a mild detergent solution or wiped with a disinfectant commonly used in patient rooms that is compatible with plastics, anodized aluminium and die cast zinc.

## Inspection and Testing

Medical Gas Outlets should be inspected periodically or at least once a year. The test should be in accordance with NFPA 99 "Gas and Vacuum systems", or CSA Z7396.1-06 "Nonflammable Medical Gas Piping System".

**Test for leaks:** Ensure that no leaks exist, with or without the adapter inserted.

**Test for Indexing:** Only a mating gas specific adapter should insert smoothly into the outlet, latch and be retained.

**Test for Flow:**

- Gas Outlets: 120 l/min (4.2 scfm) @ 345 kPa (50 psi), maximum allowable pressure drop is 28 kPa (4 psi).
- Nitrogen Outlet: 400 l/min (14.1 scfm) @ 1,250 kPa (180 psi), maximum allowable pressure drop is 70 kPa (10 psi).
- Vacuum Outlet: 30 l/min (1.1 scfm) @ 54 kPa (16 inHg), maximum allowable pressure drop is 13 kPa (4 inHg).

Refer to the appropriate standards for the proper way of performing the flow test.

Note: The Amico medical gas and vacuum outlets meet and exceed these requirements at the time of manufacture. However piping source capacity, sizing and restrictions may prevent outlets from attaining these values.

## Elevation View

To accommodate different ceiling heights, Amico Corporation has standardized ten different variations.

The column lengths range from 15" (381mm) to 42" (1067mm), with three inch (76mm) increments between all sizes.

Please select the required column height below:

L1= COLUMN HEIGHT

- 15" (381mm)
- 18" (457mm)
- 21" (533mm)
- 24" (610mm)
- 27" (686mm)
- 30" (762mm)\*
- 33" (838mm)
- 36" (914mm)\*
- 39" (991mm)
- 42" (1067mm)\*

\* = STANDARD SIZE

CEILING HEIGHT IS

\_\_\_\_\_

COLUMN HEIGHT IS:

\_\_\_\_\_

QTY.=

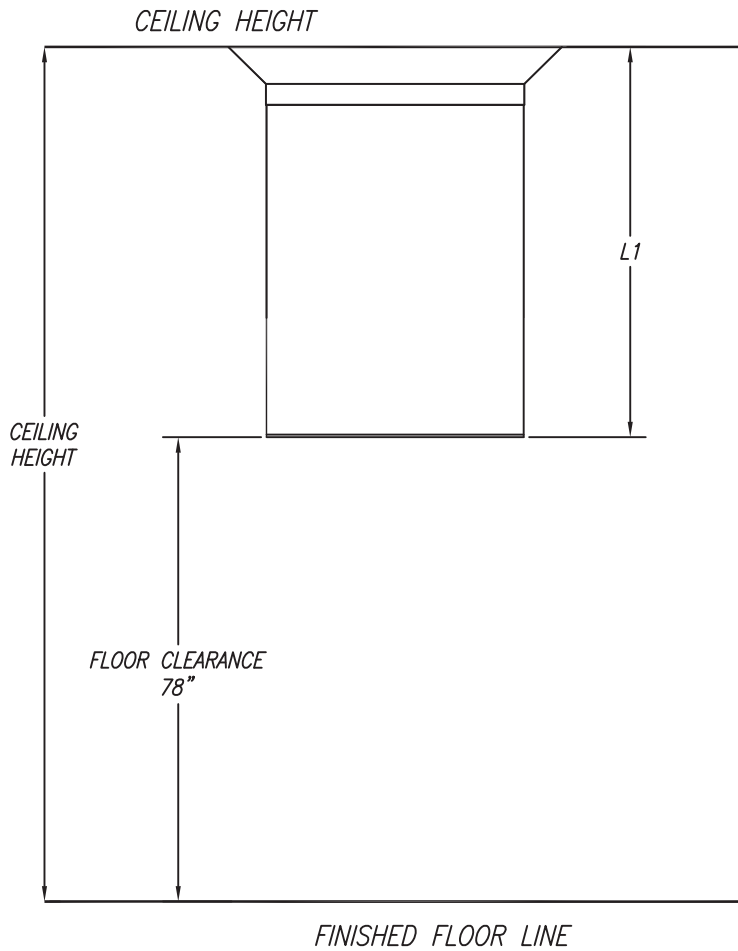





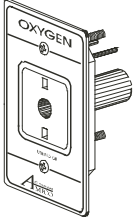
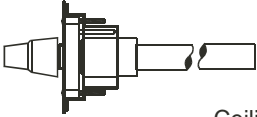

Approval Signature

Date

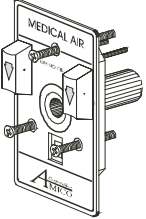
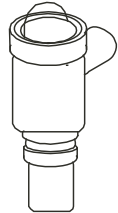
Phone No.

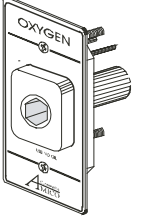
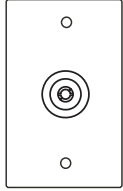
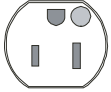
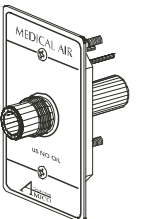
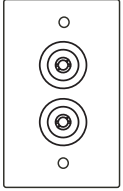
## Device and Accessory Chart

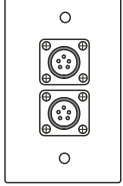
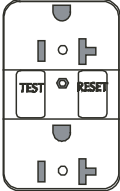
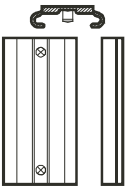
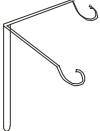
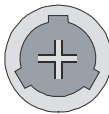
 <p><input type="checkbox"/> *QD XXX</p> <p>Ohmeda / Medaes Compatible</p>	 <p><input type="checkbox"/> PE</p> <p>Ceiling Column Passive Evacuation (19mm/33mm)</p>	 <p><input type="checkbox"/> E9-RED <input type="checkbox"/> E10-IVO.</p> <p>Duplex Receptacle 8300-HG 125V/20a (US / International)</p>	
 <p><input type="checkbox"/> CH XXX</p> <p>Chemetron Compatible</p>	 <p><input type="checkbox"/> IMP</p> <p>Passive Evacuation with Impedance Valve (19mm/22mm) (Side Mount Only)</p>	 <p><input type="checkbox"/> E11-RED <input type="checkbox"/> E12-IVO.</p> <p>Single Receptacle 8310-HG 125V/20a (US / International)</p>	
 <p><input type="checkbox"/> PB XXX</p> <p>Puritan-Bennett Compatible</p>	 <p><input type="checkbox"/> GJ</p> <p>Ground Jack Receptacle Single Hampden (SLR-3) GREEN</p>	 <p><input type="checkbox"/> E5-RED <input type="checkbox"/> E6-IVO.</p> <p>Duplex Receptacle 8200-HG 125V/15a (CAN / International)</p>	
 <p><input type="checkbox"/> *DI XXX</p> <p>DISS</p>	 <p><input type="checkbox"/> GJ2</p> <p>Ground Jack Receptacle Dual Hampden (SLR-3) GREEN</p>	 <p><input type="checkbox"/> E7-RED <input type="checkbox"/> E8-IVO.</p> <p>Single Receptacle 8210-HG 125V/15a (CAN / International)</p>	
 <p><input type="checkbox"/> OX XXX</p> <p>Oxequip Compatible</p>	 <p><input type="checkbox"/> MJ</p> <p>Monitor Jack Duplex (5-pin shown) Amphenol Model 10-825806-05S 97-14S-5S</p>	 <p><input type="checkbox"/> E13-RED <input type="checkbox"/> E14-IVO. <input type="checkbox"/> E13C-RED <input type="checkbox"/> E14C-IVO.</p> <p>Ground Fault Circuit Interrupter (C = Canadian)</p>	
 <p><input type="checkbox"/> SL</p> <p>Vacuum Bottle Slide</p>	 <p><input type="checkbox"/> IV</p> <p>Stainless Steel IV Hook (Duplex only)</p>	<p><input type="checkbox"/> DJ <input type="checkbox"/> DP</p> <p>Data - Telephone Communication Jack or Duplex Receptacle (Provision Only)</p> <p>DP - Duplex Receptacle Provision</p>	 <p><input type="checkbox"/> TL</p> <p>Twist-Lock Receptacle Hubbell 23000-HG 125V/20a</p>

All electrical devices are HUBBELL brand

**\*NOTE:** Carbon Dioxide outlets are not available in Puritan-Bennett. Nitrogen outlets are only available in DISS.

**\*NOTE:** Passive Evacuation for retractable will provide 20 ft length of 3/4" PVC hose for connection in ceiling. 3/4" Type L copper pipe will be provided for stationary columns extending 8" above ceiling plate.

## Device Placement (Bottom View)

Please fill the devices that you require for your application.  
 (Specify by using the symbols on Page 5 of this Approval Booklet.)

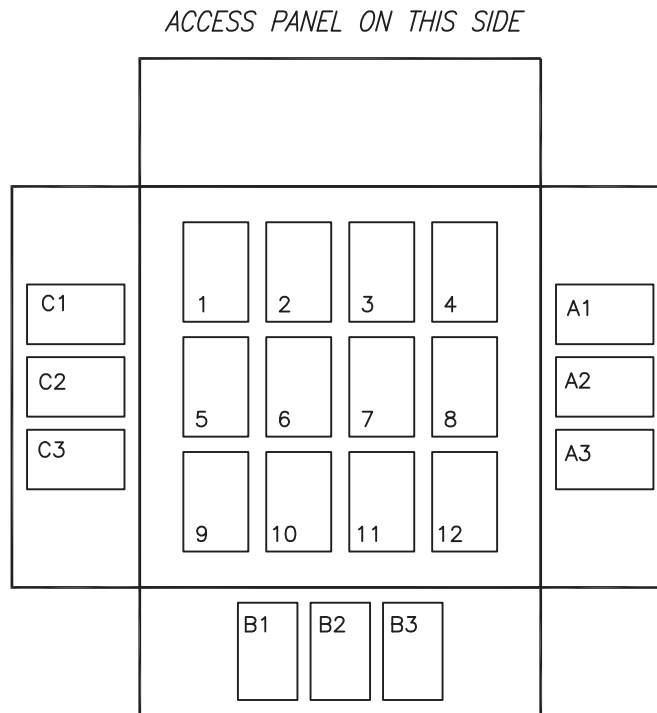

*BOTTOM VIEW  
 LOOKING UP*

Positions 1 - 12 = Medical Gas Outlets  
 Positions A1 - C3 = Electrical and/or Communication Devices

\_\_\_\_\_  
 Approval Signature

\_\_\_\_\_  
 Date

\_\_\_\_\_  
 Phone No.

## Electrical Diagram (Bottom View)

\*Please select one of the following:

- Amico recommended circuit schedule based on layout
- Custom circuit schedule. Please specify on the drawing.

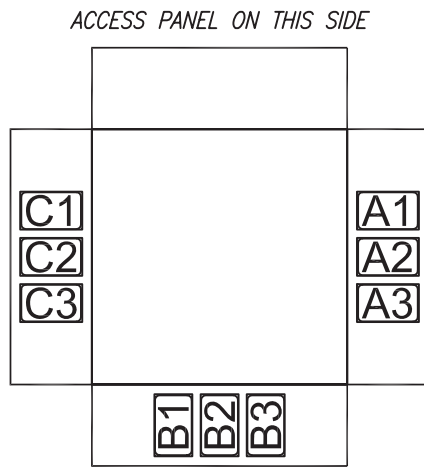

CIRCUIT NUMBER	CIRCUIT NUMBER
A1	B1
A2	B2
A3	B3

CIRCUIT NUMBER
C1
C2
C3

\*Please specify electrical details:

Type of wire:

- THHN     XHHW     RW90

AWG wire gauge:

LIVE/HOT \_\_\_\_\_  
 NEUTRAL \_\_\_\_\_  
 GROUND \_\_\_\_\_

Color:

\_\_\_\_\_  
 \_\_\_\_\_

- Isolated Power

Please select one of the following:

- All receptacles shall be mounted with ground pin "DOWN"
- All receptacles shall be mounted with ground pin "UP" (Default)

**NOTE:** A pull-string will be provided to be connected by others for all ground jacks.

**NOTE:**

1. If type of wire & gauge is not specified, Amico will use the following:  
For US/International
  - 12 Ga. THHN Wire (Std. Wiring)
  - 10 Ga. THHN Wire (All grounds)For Canada
  - 12 Ga. RW90 Wire (Std. Wiring)
  - 10 Ga. RW90 Wire (All grounds)
2. Conduit: 1/2" rigid EMT  
 (3/4" rigid EMT for low voltage pro.)

\_\_\_\_\_  
 Approval Signature

\_\_\_\_\_  
 Date

\_\_\_\_\_  
 Phone No.

# Mounting Plate to Outlet Detail

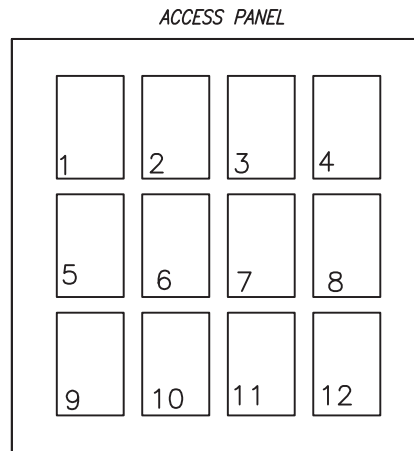
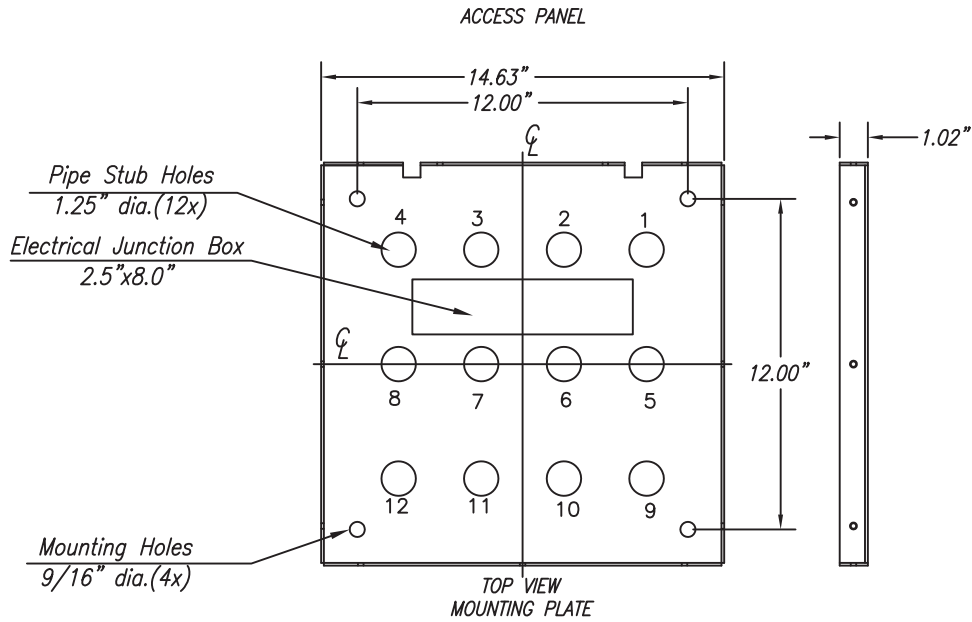

**NOTE:**

1. Gases will be manifolded for single point connections from source.
2. All pipes will extend 8" from the top of mounting plate.
3. Pipe stubs diameters are:
  - 3/4" dia. for vacuum, WAGD, and AGSS (Type L)
  - 1/2" dia. for medical air, oxygen, and nitrous oxide (Type L)
  - 1/2" dia. for nitrogen (Type K)
4. Exact locations of gas terminations on mounting plate will be determined after receiving the booklet.

Approval Signature

Date

Phone No.

## Mounting Information

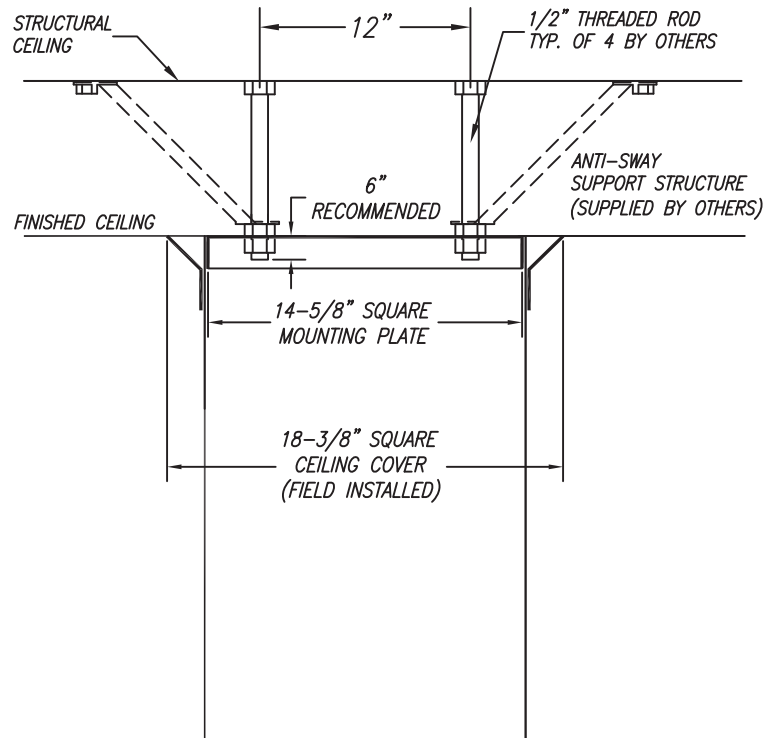

**NOTE:**

1. 1/2" Support rods located for total support of fixture (minimum 400 lb. load), all labor and materials for support fabrication including nuts and washers for installation supplied by General Contractor.
2. General Contractor has final responsibility for the strength and stability of the mounting structure.
3. Mounting structure and all hardware necessary supplied by General Contractor.

Approval Signature

Date

Phone No.

## Typical Location View

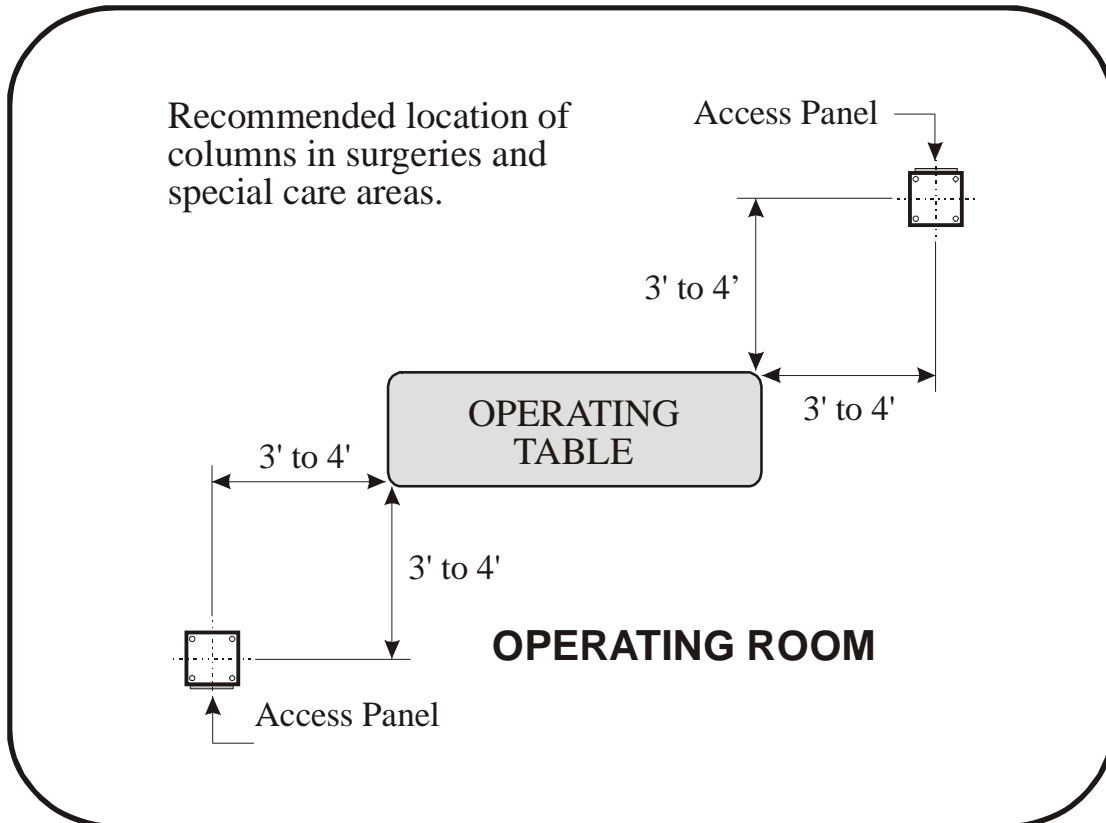

the right **connection**





85 Fulton Way, Richmond Hill  
Ontario, L4B 2N4, Canada

31 Sprague Avenue, Amityville  
NY 11701, USA

Toll Free Tel: 1.877.462.6426  
Toll Free Fax: 1.866.440.4986  
Tel: 905.764.0800 | Fax: 905.764.0862  
[www.amico.com](http://www.amico.com)

represented by: