



manual retractable ceiling column approval booklet



Table of Contents

Product Description	3
Cleaning	3
Inspection and Testing	3
Standard Range of Column Retraction	4
Elevation View	5
Device and Accessory Chart	6
Device Placement (Bottom View)	7
Electrical Diagram (Bottom View)	8
Riser Plate to Outlet Detail	9
Mounting Information	10
Typical Location View	11

Product Description

The manual retractable ceiling column shall be an Amico Alert-1 series.

The retractable ceiling column shall be of the manual operated type. The column shall consist of an upper section for rigid mounting at the ceiling level and a telescopic lower section capable of being extended to a maximum of 18 inches.

The retractable section of the column is activated by a coiled spring mechanism and can be lowered or raised at any position. The rotation of the handle will allow the column to become motionless or mobile. With the aid of an internal tracking system, the movement of the telescoping portion will glide freely up or down.

The upper and lower section shrouds are made of 16 gauge stainless steel with a # 4 satin finish and are complete with: Removable access panel, stainless steel ceiling collar and a heavy gauge steel mounting plate, equipped with hose assemblies (gas specific) within the internal shell of the column and brazed type copper fittings for all medical gas connections above the ceiling line.

All electrical and medical gas services are provided to the face of the lower section by means of flexible hoses and conduits. All threaded connections comply with NFPA, CGA and DISS recommendations preventing interchanging of connections. All services are pre-assembled and factory tested. Standard dimensions are 13-9/16" X 13-9/16" for the upper section and 12" X 12" for the lower section.

NOTE: Electrical devices are pre-wired, unless otherwise stated.

Cleaning

The Amico Outlets are factory cleaned for oxygen service. Exposed surfaces of the outlet may be cleaned with a mild detergent solution or wiped with a disinfectant commonly used in patient rooms that is compatible with plastics, anodized aluminium and die cast zinc.

Inspection and Testing

Medical Gas Outlets should be inspected periodically or at least once a year. The test should be in accordance with NFPA 99 "Gas and Vacuum systems", or CSA Z7396.1-06 "Nonflammable Medical Gas Piping System".

Test for leaks: Ensure that no leaks exist, with or without the adapter inserted.

Test for Indexing: Only a mating gas specific adapter should insert smoothly into the outlet, latch and be retained.

Test for Flow:

- Gas Outlets: 120 l/min (4.2 scfm) @ 345 kPa (50 psi), maximum allowable pressure drop is 28 kPa (4 psi).
- Nitrogen Outlet: 400 l/min (14.1 scfm) @ 1,250 kPa (180 psi), maximum allowable pressure drop is 70 kPa (10 psi).
- Vacuum Outlet: 30 l/min (1.1 scfm) @ 54 kPa (16 inHg), maximum allowable pressure drop is 13 kPa (4 inHg).

Refer to the appropriate standards for the proper way of performing the flow test.

NOTE: The Amico medical gas and vacuum outlets meet and exceed these requirements at the time of manufacture. However piping source capacity, sizing and restrictions may prevent outlets from attaining these values.

Standard Range of Column Retraction

To accommodate for different ceiling heights, Amico Corporation has standardized three different variations.

The **LOW** height is designed for ceilings below 9' - 0" (2743mm)

The **MEDIUM** height is designed for ceilings between 9' - 1" (2769mm) and 9' - 11" (3023mm)

The **HIGH** height is designed for ceilings above 10' - 0" (3048mm)

Please select the column height below that applies to you application.

*Please use Page 5 for any desired size that is not shown.

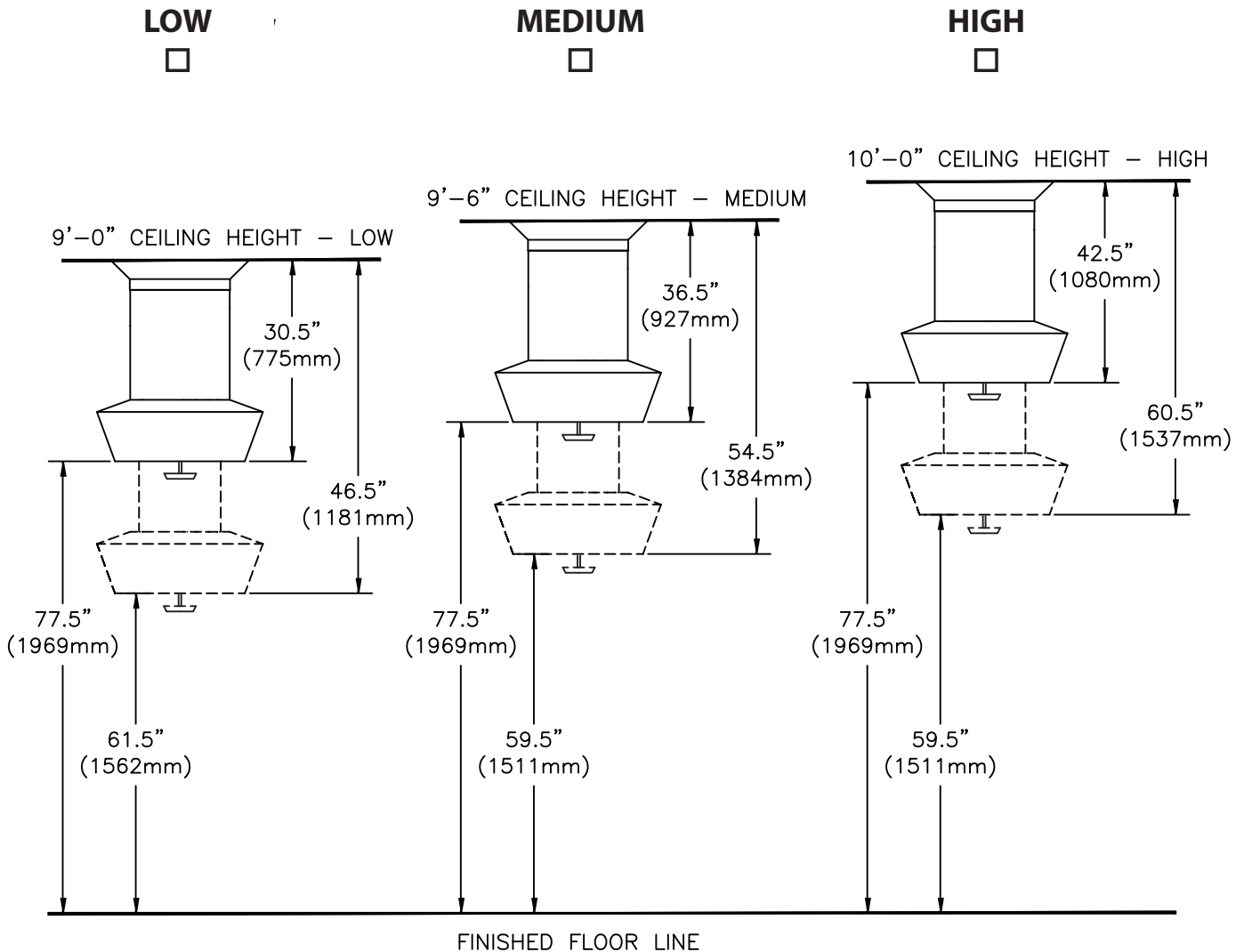

Approval Signature

Date

Phone No.

Elevation View

Please fill in the dimensions required for the custom column shell.

- The smallest unit size is 24".
- Please note there is a 14" mechanism at the top of the column.
- Maximum retraction 18".

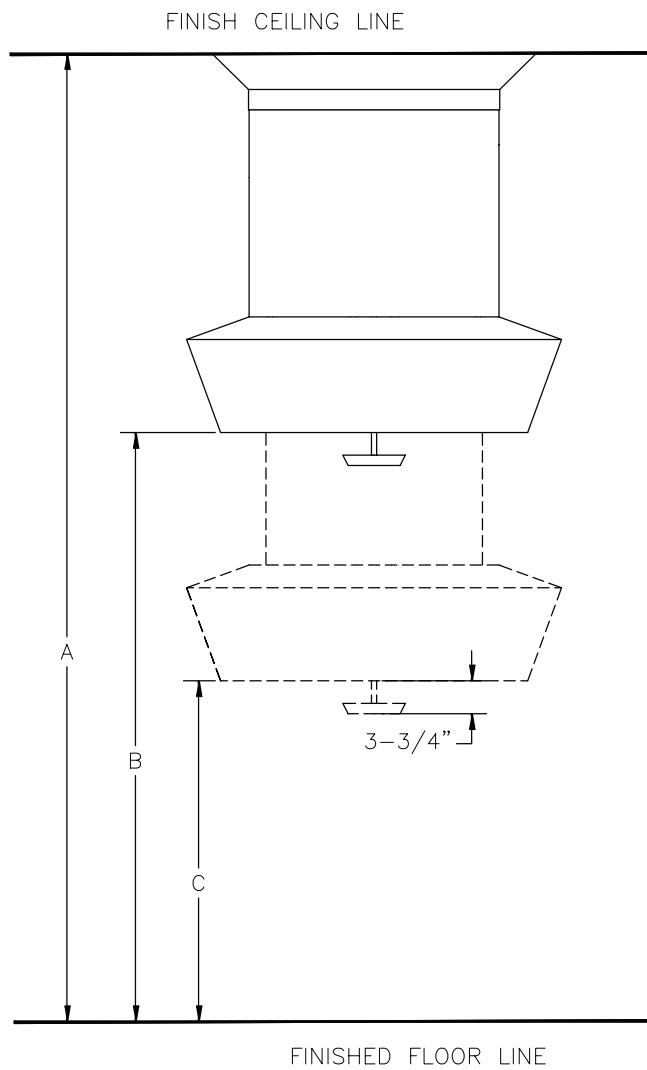

PLEASE PROVIDE THE FOLLOWING INFORMATION:

A=
B=
C=







QTY.=

Approval Signature

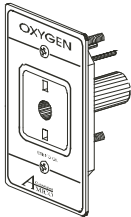
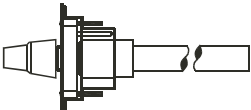
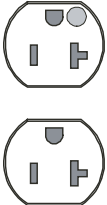
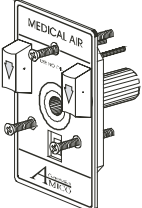
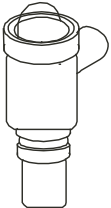
Date

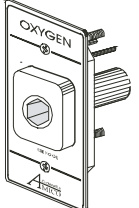
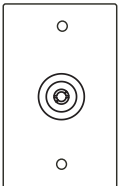
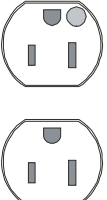
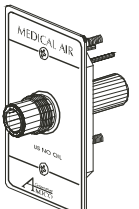
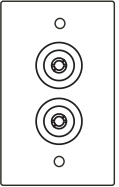
Phone No.

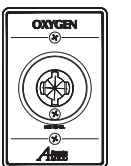
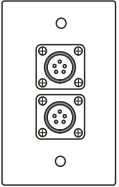
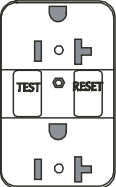
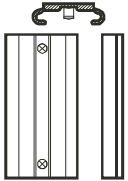
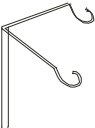
Device and Accessory Chart

 <p><input type="checkbox"/> *QD XXX</p> <p>Ohmeda / Medaes Compatible</p>	 <p><input type="checkbox"/> PE</p> <p>Ceiling Column Passive Evacuation (19mm/33mm)</p>	 <p><input type="checkbox"/> E9-RED <input type="checkbox"/> E10-IVO.</p> <p>Duplex Receptacle 8300-HG 125V/20a (US / International)</p>	
 <p><input type="checkbox"/> CH XXX</p> <p>Chemetron Compatible</p>	 <p><input type="checkbox"/> IMP</p> <p>Passive Evacuation with Impedance Valve (19mm/22mm) (Side Mount Only)</p>	 <p><input type="checkbox"/> E11-RED <input type="checkbox"/> E12-IVO.</p> <p>Single Receptacle 8310-HG 125V/20a (US / International)</p>	
 <p><input type="checkbox"/> PB XXX</p> <p>Puritan-Bennett Compatible</p>	 <p><input type="checkbox"/> GJ</p> <p>Ground Jack Receptacle Single Hampden (SLR-3) GREEN</p>	 <p><input type="checkbox"/> E5-RED <input type="checkbox"/> E6-IVO.</p> <p>Duplex Receptacle 8200-HG 125V/15a (CAN / International)</p>	
 <p><input type="checkbox"/> *DI XXX</p> <p>DISS</p>	 <p><input type="checkbox"/> GJ2</p> <p>Ground Jack Receptacle Dual Hampden (SLR-3) GREEN</p>	 <p><input type="checkbox"/> E7-RED <input type="checkbox"/> E8-IVO.</p> <p>Single Receptacle 8210-HG 125V/15a (CAN / International)</p>	
 <p><input type="checkbox"/> OX XXX</p> <p>Oxequip Compatible</p>	 <p><input type="checkbox"/> MJ</p> <p>Monitor Jack Duplex (5-pin shown) Amphenol Model 10-825806-05S 97-14S-5S</p>	 <p><input type="checkbox"/> E13-RED <input type="checkbox"/> E14-IVO. <input type="checkbox"/> E13C-RED <input type="checkbox"/> E14C-IVO.</p> <p>Ground Fault Circuit Interrupter (C = Canadian)</p>	
 <p><input type="checkbox"/> SL</p> <p>Vacuum Bottle Slide</p>	 <p><input type="checkbox"/> IV</p> <p>Stainless Steel IV Hook (Duplex only)</p>	<p><input type="checkbox"/> DJ <input type="checkbox"/> DP</p> <p>Data - Telephone Communication Jack or Duplex Receptacle (Provision Only)</p> <p>DP - Duplex Receptacle Provision</p>	 <p><input type="checkbox"/> TL</p> <p>Twist-Lock Receptacle Hubble 23000-HG 125V/20a</p>

All electrical devices are HUBBELL brand

***NOTE:** Carbon Dioxide outlets are not available in Puritan-Bennett. Nitrogen outlets are only available in DISS.

***NOTE:** Passive Evacuation for retractable will provide 20 ft length of 3/4" PVC hose for connection in ceiling. 3/4" Type L copper pipe will be provided for stationary columns extending 8" above ceiling plate.

Device Placement (Bottom View)

Please fill the devices that you require for your application.
(Specify by using the symbols on Page 6 of this Approval Booklet.)

ACCESS PANEL ON THIS SIDE

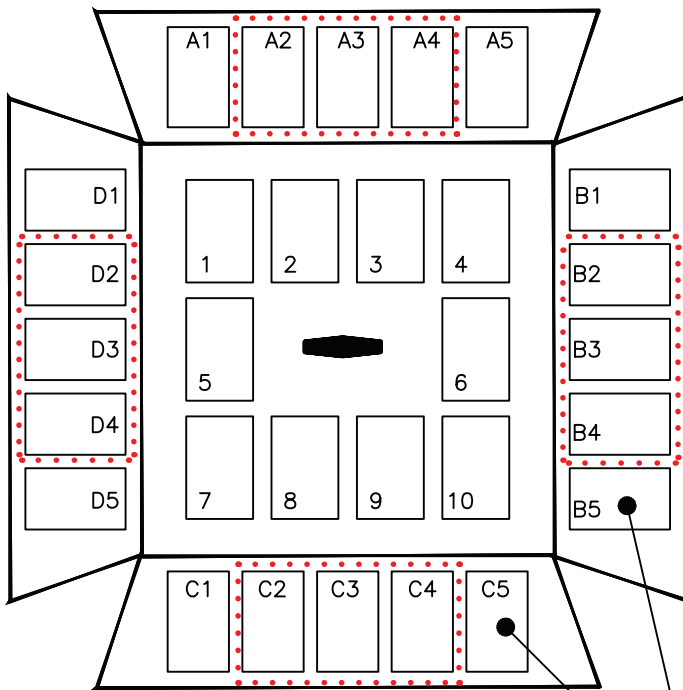

BOTTOM VIEW
LOOKING UP

"SEE NOTE NO. 1"

Nitrogen Control Panel?

Yes

No

Location of Panel:

Side A

Side B

Side C

Side D

Please Specify Outlet Language:

US

CAN

FRENCH

SPANISH/US

SPANISH/ISO

NOTE:

1. Two electrical/communication devices cannot be placed together at any corner.
2. Maximum of 10 gas outlets are allowed on the column. If 12 gas outlets are required, then side mount is optional.
3. All electrical devices must be located within only section A, B, C, or D.
4. The Nitrogen Control Panel will occupy three spaces of the bulkhead (E.G. A2 to A4 SEE OUTLINE).

Approval Signature

Date

Phone No.

Electrical Diagram (Bottom View)

*Please select one of the following:

- Amico recommended circuit schedule based on layout
- Custom circuit schedule. Please specify on the drawing.

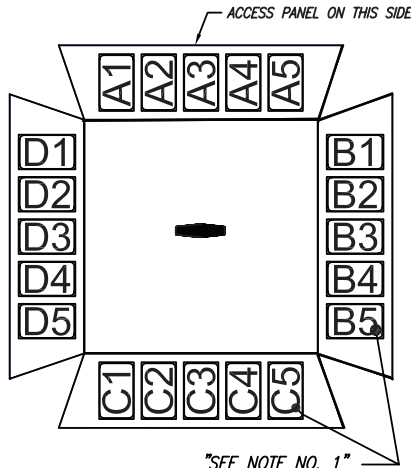

Receptacle Type:

- US/CAN
- BRITISH
- GERMAN

*Please specify details:

Type of wire:

- THHN
- XHHW
- RW90

AWG wire gauge:

LIVE/HOT _____
 NEUTRAL _____
 GROUND _____

Color:

- Isolated Power

Please select one of the following:

- All receptacles shall be mounted with ground pin "DOWN"
- All receptacles shall be mounted with ground pin "UP" (Default)

NOTE: A pull-string will be provided to be connected by others for all ground jacks.

CIRCUIT NUMBER	CIRCUIT NUMBER
A1 *	B1 *
A2	B2
A3	B3
A4	B4
A5 *	B5 *

CIRCUIT NUMBER	CIRCUIT NUMBER
C1 *	D1 *
C2	D2
C3	D3
C4	D4
C5 *	D5 *

* SEE NOTE NO. 1

NOTE:

1. Two electrical/communication devices cannot be placed together at any corner.
2. If type of wire & gauge is not specified, Amico will use the following:
For US/International
 - 12 Ga. THHN Wire (Std. Wiring)
 - 10 Ga. THHN Wire (All grounds)For Canada
 - 12 Ga. RW90 Wire (Std. Wiring)
 - 10 Ga. RW90 Wire (All grounds)
3. Conduit: 9/16" flexible metal conduit
4. All conduits and wires will extend 12" above finish column for connection to riser plate.

Approval Signature

Date

Phone No.

Riser Plate to Outlet Detail

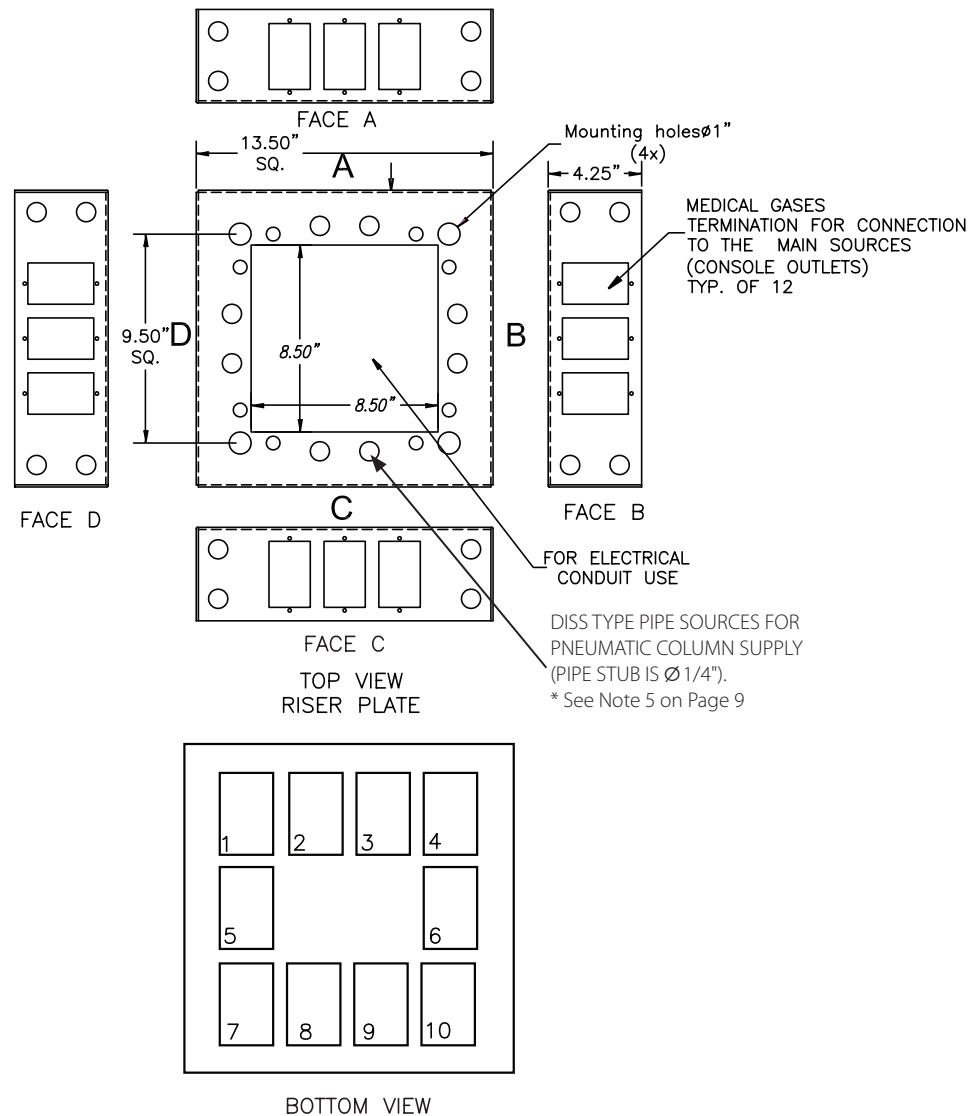

NOTE:

1. Riser plate is completed with DISS console outlets, typical for each gas.
2. Pipe stubs diameters are 3/8" ID and 1/2" OD for all gases. Refer to outlet cut sheet.
3. Exact locations of gas terminations on mounting plate will be determined after receiving the booklet. Upon request, Amico will provide a complete "mounting plate to outlet detail" diagram, showing exact loctions for gas terminations.

Approval Signature

Date

Phone No.

Mounting Information

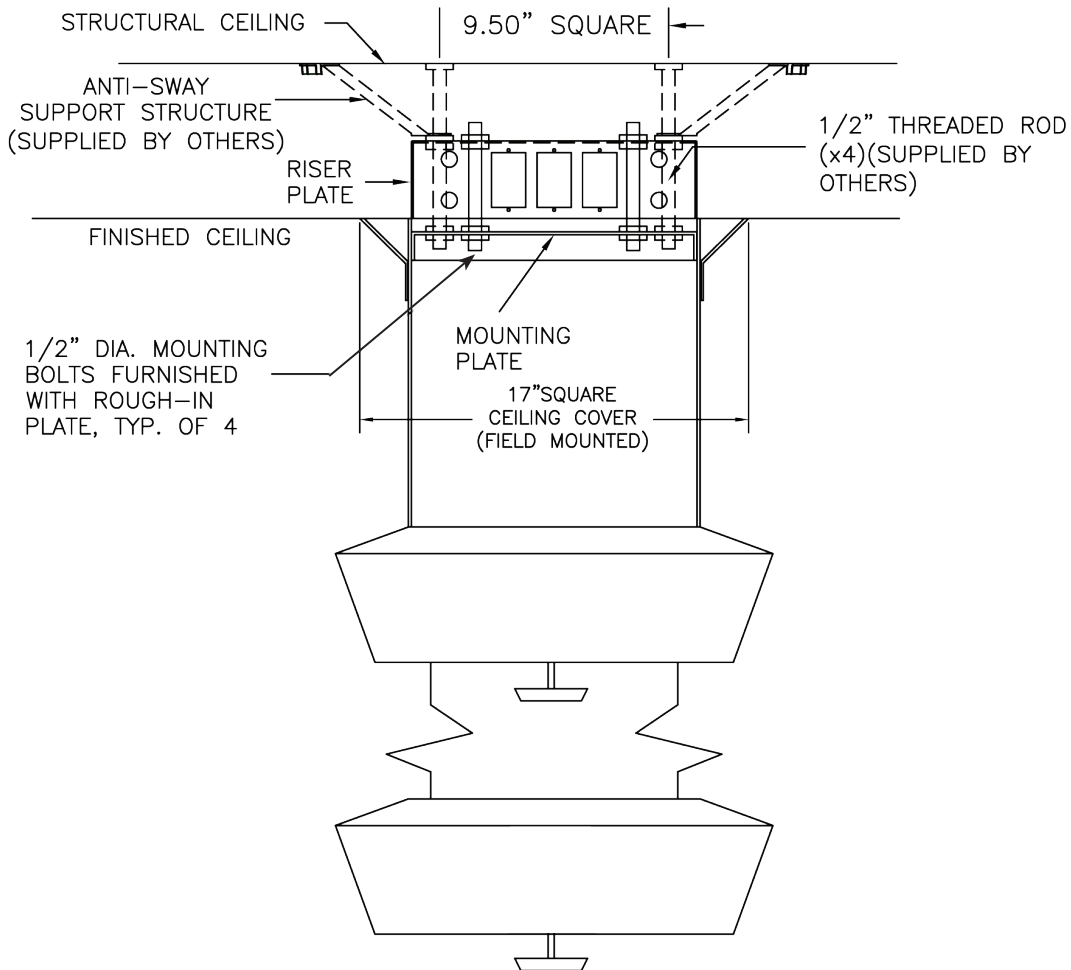

NOTE:

1. 1/2" Support rods located for total support of fixture (minimum 400 lb. load), all labor and materials for support fabrication including nuts and washers for installation supplied by General Contractor.
2. General Contractor has final responsibility for the strength and stability of the mounting structure.
3. Mounting structure and all hardware necessary supplied by General Contractor.
4. Riser plate to be mounted flush with finished ceiling.
5. Space between top of Riser Plate and structural ceiling must be minimum 12".

Approval Signature

Date

Phone No.

Typical Location View

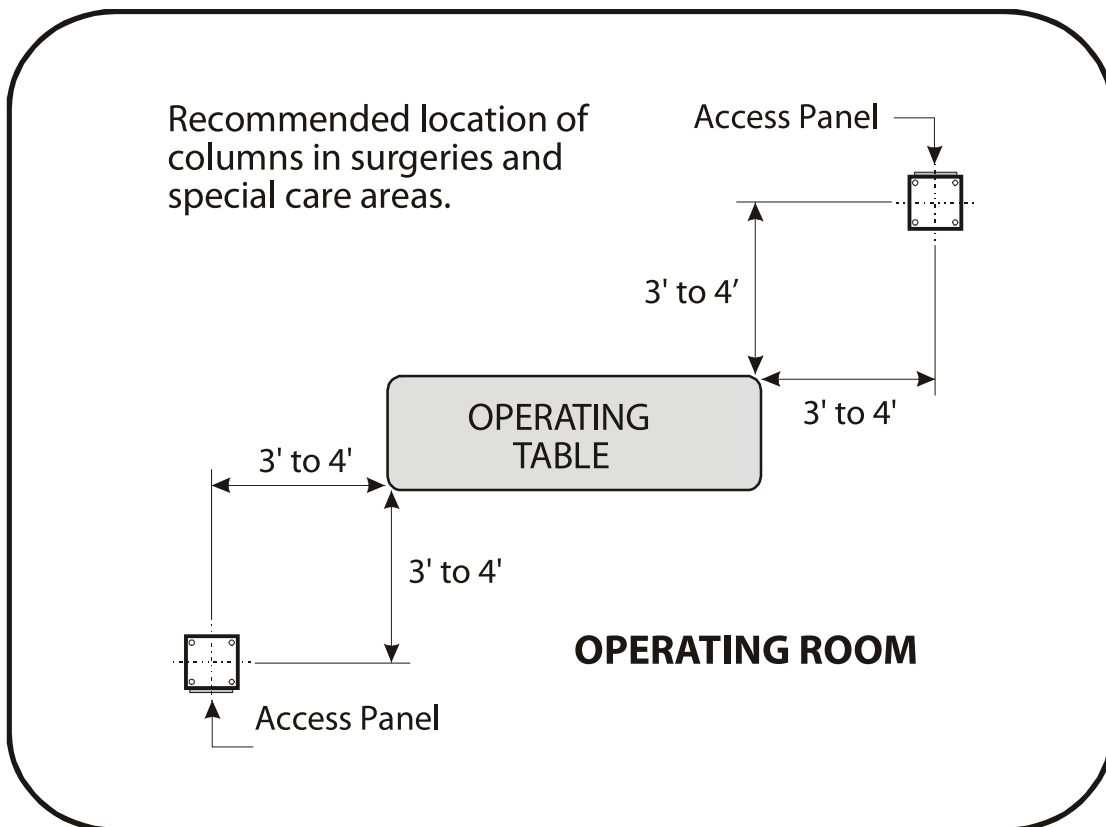



85 Fulton Way, Richmond Hill
Ontario, L4B 2N4, Canada

71 East Industry Court, Deer Park,
NY 11729, USA

Toll Free Tel: 1.877.462.6426
Toll Free Fax: 1.866.440.4986
Tel: 905.764.0800 | Fax: 905.764.0862
www.amico.com

represented by: