

Simplex Oil-Less Scroll Lab Air Package 7.5 HP Tank Mount
Air Compressor Package

- One oil-less scroll air compressor with inlet filter
- One motor
- ASME coded air receiver
- Simplex control panel
- All discharge air piping and fittings - ASTM B-819 copper tubing, brass and/or stainless steel
- All components completely pre-piped, pre-wired and tested prior to shipment

Air Compressor Module

- Continuous duty rated with permanently lubricated, sealed bearings
- Single stage scroll type
- Air-cooled
- Constructed of one fixed and one orbiting scroll sealed with PTFE tip seals between the scroll halves
- Rated for 120 psig discharge pressure
- Protected from dust or contamination with a two part face seal
- Orbiting bearings - grease filled
- Drive Bearings – Grease filled and lip sealed
- Drive bearing maintenance interval – 10,000 hours
- Scroll housing constructed of die cast aluminum
- V-belt drive with means of adjustment
- OSHA approved, totally enclosed belt guard
- Each compressor discharge line equipped with a safety relief valve and check valve

Compressor Motor

- NEMA rated
- Open drip proof
- 3600 RPM, with 1.15 service factor
- 208 or 230/460V

Air Receiver

- ASME Code stamped
- National Board Certified
- Rated for a minimum 200 PSIG design pressure
- Safety relief valve
- Auto drain valve

Control System

- Mounted and wired simplex control panel
- NEMA 12 and U.L. labeled
- Pressure gauge
- Runtime hourmeters
- Full voltage motor starter with overload protection
- 120V control circuit transformer
- Off/On illuminated selector switch

OPTIONAL
Vibration Isolation System

- Four-point heavy duty isolators
- Seismically restrained isolators

Air Receiver

- Galvanized
- 3 valve by-pass
- Sight glass

Dryer/Filter/Regulator System

- Final line regulator and safety relief valve
- Air sample port
- Simplex refrigerated dryer
- Simplex desiccant air dryer with purge saving
 - High efficiency coalescing pre-filter rated for 0.01 micron with automatic drain & element change indicator
 - Particulate final line filters rated for 0.01 micron with element change indicator
- Mounted aftercooler (required with air dryer)
- Dryer by-pass valves

Dew Point Hygrometer/CO Monitor

- Dew point hygrometer mounted, pre-piped, wired and includes remote alarm contacts
 - Hygrometer sensor - ceramic type
 - Accuracy - minimum of $\pm 2^\circ$ F for dew point
 - Dew point alarm - factory set at 36° F (2° C)
 - Set point is field adjustable
 - High dew point conditions indicated with visual and audible alarms
- CO Monitor with integral chemical CO sensor - mounted, pre-piped, wired and includes remote alarm contacts
 - Accuracy - minimum of ± 2 PPM (at 10 PPM) for CO
 - CO alarm - factory set at 10 PPM
 - Set points field adjustable
 - High CO indicated with visual and audible alarms

Control System

- High discharge air temperature switch with remote alarm
- High inlet vacuum switch
- Circuit breaker
- Circuit breaker with through the door disconnect
- **SIGNAL 1™** – touch screen gateway

Standard Screen Displays

- | | |
|------------------------|--|
| + Air level/Runtime | + Replacement parts |
| + Alarm history | + Troubleshooting guidelines |
| + Service indicator | + Historical Trending of system status |
| + Maintenance schedule | |
- + 7" Wide TFT Graphic Touch Screen with Motion Actuated Backlit LED and Bright 65,536 (16-bit) Colors
 - + Downloadable Trend Information via USB Host Port or Network Device
 - + 128MB Flash Memory, 64MB DRAM
 - + Built-in Ethernet Port 10/100 Base-T (RJ45)
 - + Supports over 100 Communication Protocols including BACnet IP, Ethernet IP, and Modbus TCP/IP
 - + Built-in Multiple Ports it can handle three (3) additional Protocols simultaneously
 - + Built-in VNC server allowing remote monitoring over Ethernet/Internet network for "Real Time" monitoring of live graphics through standard browser, smart phones & mobile devices
 - + Share data between HMI and Building Management systems with no additional software to implement

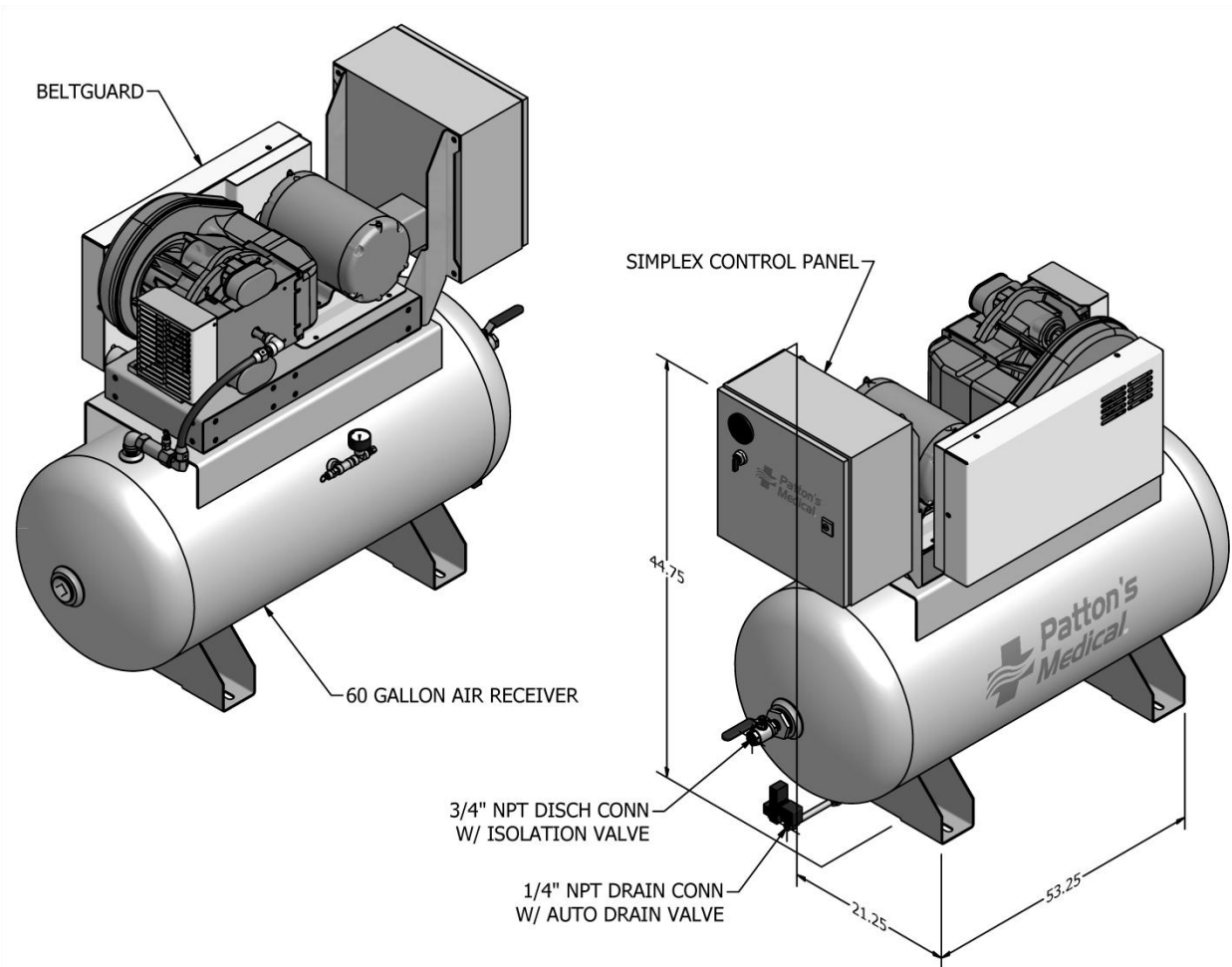

Simplex Scroll Lab Air Package Specifications ¹										
Complete Package Model No.	HP	System Capacity ²		Package BTU/HR	Receiver	Noise Level ³	System FLA			Weight
		50 psig	110 psig				A 208V	B 230V	C 460V	
68-11-076A	7.5	25.2	24.0	17,062	60 Gal.	72	25	23	12	519
68-11-076B										
68-11-076C										

Notes:

¹ Normal Operating conditions at a maximum ambient of 105° F. Consult factory for higher ambient conditions.

² Capacities are shown as system capacities and are shown in Inlet Cubic Feet per Minute (ICFM).

³ Noise levels are shown in dB(A).

Statement of Warranty

Patton's Medical warrants all Control Air packages, to be free of defects in material and workmanship under normal use for a period not to exceed thirty (30) months from date of shipment, or twenty-four (24) months from date of start-up.