

## NFPA 99 Compliant Triplex “Oil-Less” Claw Medical Vacuum Package – “O<sub>2</sub> Safe” 7.5 HP Base Mounted with Single Point Connection

### Vacuum Package

- Fully compliant with the latest edition of NFPA 99
- Three oil-less rotary claw type vacuum pumps with inlet filter and isolation valve for each
- Three motors
- ASME coded vacuum receiver with bypass and manual drain
- Triplex control panel with automatic lead/lag controls
- System designed for access through a standard 36” doorway
- All components completely pre-piped and pre-wired to single point service connections
- Liquid tight conduit, fittings and junction boxes for all control and power wiring
- All interconnecting piping and wiring is completed and operationally tested prior to shipment

### Vacuum Pump

- Oil-less rotary claw pump
- Direct-driven through a shaft coupling
- Air-cooled
- End (ultimate) vacuum = 27" Hg
- Dry-running, with two claw-type, non-contacting rotors
- Sealing fluid not required
- Virtually maintenance-free operation
- Oil change required at approximately 20,000 operating hour intervals in the gearbox only
- Built-in, anti-suck-back valve mounted at the pump inlet and equipped with a 2 micron inlet filter for removal of particulates

### Vacuum Motor

- NEMA rated
- C-face
- TEFC
- 3600 RPM, with 1.15 service factor
- 208 or 230/460V 3-phase

### Intake Piping

- Inlet check valve on each pump
- Inlet isolation valve on each pump
- Flexible connector between pump and manifold
- Flexible connectors for inlet and discharge and vibration pads included

### Vacuum Receiver

- Vertical orientation with integrally mounted bypass and manual drain
- ASME Code stamped
- National Board Certified
- Rated for a minimum 200 PSIG design pressure
- Vacuum gauge
- Manual drain

### Control System

- Mounted and wired triplex control system
- NEMA 12 and U.L. labeled
- Automatic lead/lag sequencing
- Circuit breaker disconnects for each motor with external operators
- Full voltage motor starters with overload protection
- 120V control circuit transformers for each motor circuit
- Visual and audible reserve unit alarm with isolated contacts for remote alarm
- Hand-off-auto selector switches
- Automatic alternation of both vacuum pumps based on a first-on/first-off principle with provisions for simultaneous operation if required
- Automatic activation of reserve unit if required
- Visual and audible alarm indication for high discharge temperature shutdown with isolated contacts for remote alarm
- **SIGNAL 1™** – touch screen gateway

#### Standard Screen displays

- |                         |  |
|-------------------------|--|
| + Vacuum level /Runtime | + Replacement parts                    |
| + Alarm history         | + Troubleshooting guidelines           |
| + Service indicator     | + Historical trending of system status |
| + Maintenance schedule  |  |

- + 7” Wide TFT Graphic Touch Screen with Motion Actuated Backlit LED
- + Bright 65,536 (16-bit) Colors
- + Downloadable Trend Information via USB Host Port or Network Device
- + 128MB Flash Memory, 64MB DRAM
- + Built-in Ethernet Port 10/100 Base-T (RJ45)
- + Supports over 100 Communication Protocols including BACnet IP, Ethernet IP, and Modbus TCP/IP
- + With Multiple Ports it can handle three (3) additional Protocols simultaneously
- + Built-in VNC server allowing remote monitoring over Ethernet/Internet network for “Real Time” monitoring of live graphics through standard browser, smart phones and mobile devices.
- + Share data between HMI and Building Management systems with no additional software to implement.

### Oxygen Compatibility

- Safe for all WAGD applications
- Capable of operating safely at 100% oxygen content
- All parts and surfaces in contact with the flow stream are cleaned with oxygen compatible cleaner
- Pump is assembled and tested in a clean room with dedicated tools
- Fiberglass inlet filter media insures there is no fuel to ignite in the compression chamber
- Gear casing lubricant is of a special oxygen compatible formula

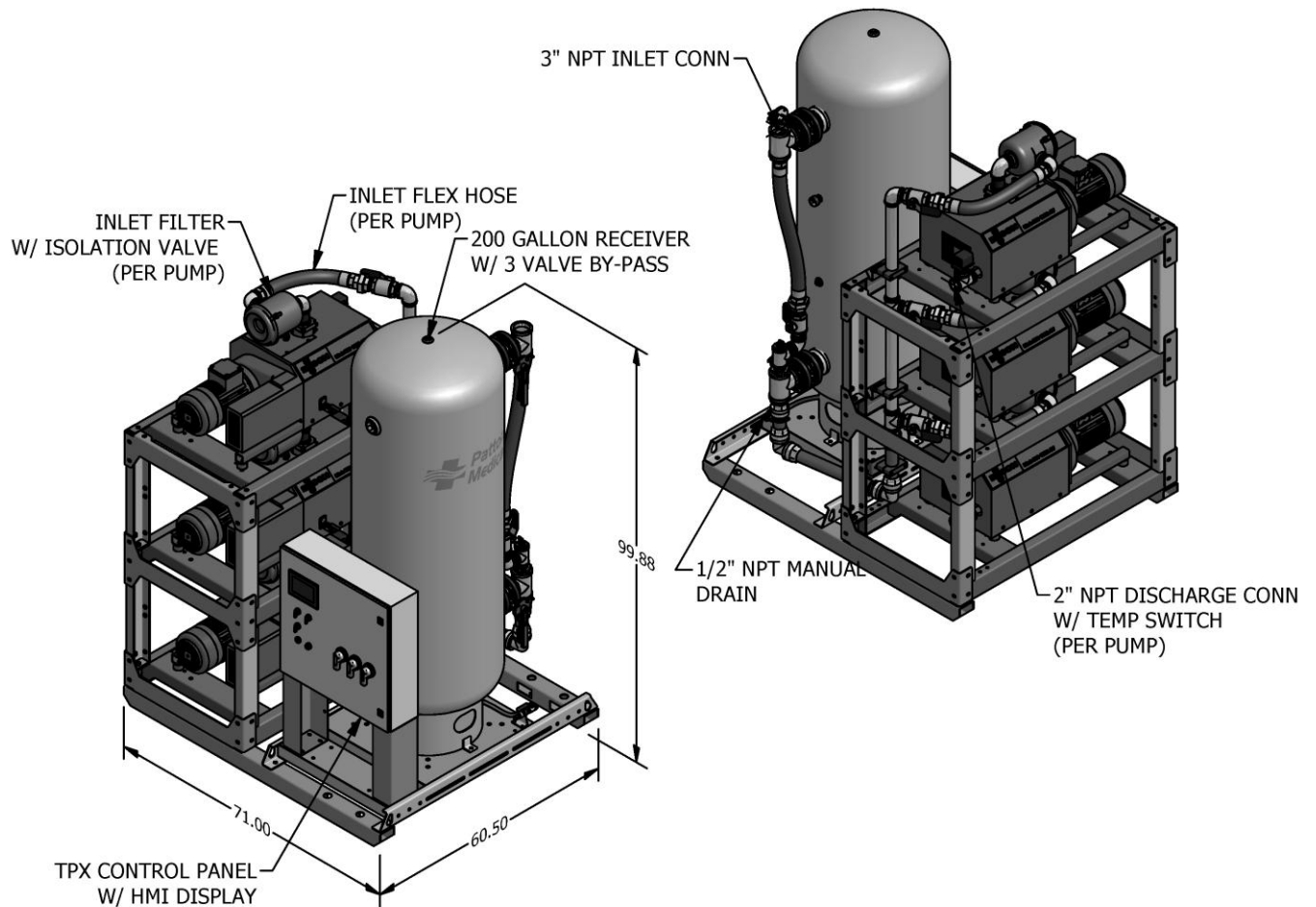

Triplex Claw Medical Vacuum Package Specifications <sup>1</sup>									
System Model No.	HP	Capacity @19" Hg <sup>2</sup>		Package BTU/HR <sup>3</sup>	Noise Level <sup>4</sup>	System FLA			Package Weight
		Pump (SCFM)	System (SCFM)			208V	230V	460V	
74-33-075A	7.5	65	130	37,740	82	79			3,298
74-33-075B							68		
74-33-075C								34	

Notes:

<sup>1</sup> Normal Operating conditions at a maximum ambient of 105° F. Consult factory for higher ambient conditions.

<sup>2</sup> Capacities are shown as NFPA system capacities (reserve vacuum pump on standby).

<sup>3</sup> Package BTU/HR are shown with the reserve pump on standby.

<sup>4</sup> Noise levels are shown in dB(A) and reflect two pumps running.

**Statement of Warranty**

Patton's Medical warrants all Medical Vacuum packages, to be free of defects in material and workmanship under normal use for a period not to exceed thirty (30) months from date of shipment, or twenty-four (24) months from date of start-up.