

## NFPA 99 Compliant Duplex Lubricated Rotary Vane Medical Vacuum Package 2 HP Horizontal Tank Mount

### Vacuum Package

- Fully compliant with the latest edition of NFPA 99
- Two lubricated rotary vane type vacuum pumps with inlet filter and isolation valve for each
- Two motors
- ASME coded horizontal vacuum receiver with bypass and manual drain
- Duplex control panel with automatic lead/lag controls
- System designed for access through a standard 36" doorway
- All components completely pre-piped and pre-wired to single point service connections
- Liquid tight conduit, fittings and junction boxes for all control and power wiring
- All interconnecting piping and wiring is completed and operationally tested prior to shipment

### Vacuum Pump

- Lubricated rotary vane pump
- Three non-metallic, non-asbestos vanes with minimum life of 30,000 hrs.
- Direct-driven through a shaft coupling
- Air-cooled
- End (ultimate) vacuum = 29.3" Hg
- Integral, fully recirculating oil supply
- Spin-on oil filter
- High discharge temperature switch
- Oil drain valve assembly with temperature gauge
- Integral oil separation system with three stage oil and smoke eliminators capable of removing 99.9+% of particles from the exhaust gas stream
- Built-in, anti-suck-back valve mounted at the pump inlet
- 2 micron inlet filter for removal of particulates
- Shipped with initial charge of pump fluid

### Vacuum Motor

- NEMA rated
- C-face
- TEFC
- 208 or 230/460V 3-phase

### Intake Piping

- Vacuum pumps are connected to a common manifold and piped to a horizontal receiver
- Inlet check valve on each pump
- Inlet isolation valve on each pump
- Flexible connectors between pumps and receiver
- Flexible connectors for discharge connections

### Vacuum Receiver

- Horizontal orientation with integrally mounted bypass and manual drain
- ASME Code stamped
- National Board Certified
- Rated for a minimum 200 PSIG design pressure
- Vacuum gauge
- Manual drain

### Control System

- Mounted and wired duplex control system
- NEMA 12 and UL 508A labeled
- Automatic lead/lag sequencing
- Circuit breaker disconnects for each motor with external operators
- Full voltage motor starters with overload protection
- 120V control circuit transformers for each motor circuit
- Visual and audible reserve unit alarm with isolated contacts for remote alarm
- Hand-off-auto selector switches for reliable back-up
- Automatic alternation of all vacuum pumps based on a first-on/first-off principle with provisions for simultaneous operation
- Automatic activation of reserve unit if required
- Visual and audible alarm indication for high discharge air temperature shutdown with isolated contacts for remote alarm
- **SIGNAL 1™** – touch screen gateway

#### Standard Screen Displays

- + Vacuum level/Runtime
- + Alarm history
- + Service indicator
- + Maintenance schedule
- + Replacement parts
- + Troubleshooting guidelines
- + Historical Trending of system status
- + 7" Wide TFT Graphic Touch Screen with Motion Actuated Backlit LED and Bright 65,536 (16-bit) Colors
- + Downloadable Trend Information via USB Host Port or Network Device
- + 128MB Flash Memory, 64MB DRAM
- + Built-in Ethernet Port 10/100 Base-T (RJ45)
- + Supports over 100 Communication Protocols including BACnet IP, Ethernet IP, and Modbus TCP/IP
- + Built-in Multiple Ports it can handle three (3) additional Protocols simultaneously
- + Built-in VNC server allowing remote monitoring over Ethernet/Internet network for "Real Time" monitoring of live graphics through standard browser, smart phones & mobile devices
- + Share data between HMI and Building Management systems with no additional software to implement

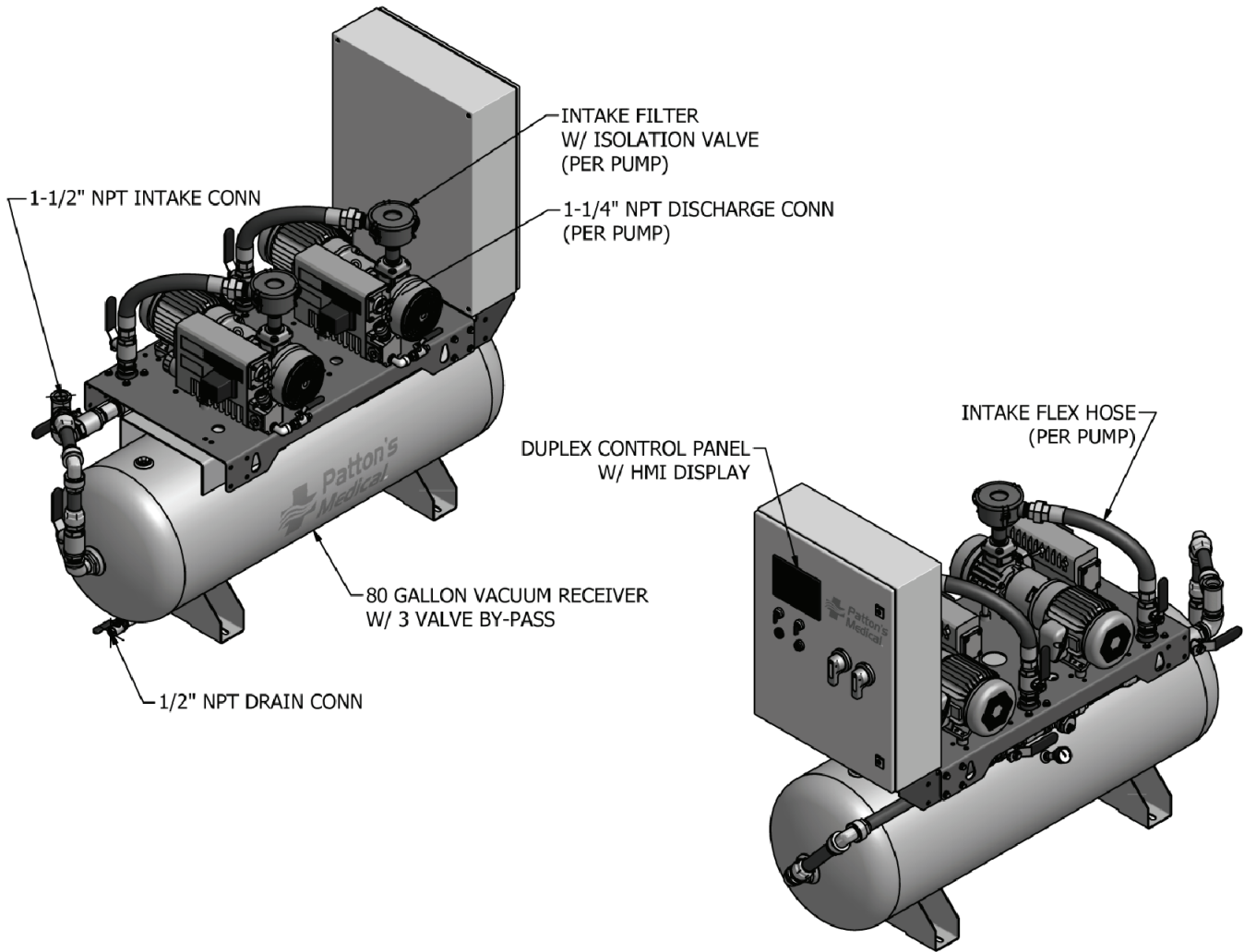

Duplex Lubricated Rotary Vane Medical Vacuum Package Specifications <sup>1</sup>											
Complete Package Model No.	HP	Capacity @19" Hg <sup>2</sup>		Package BTU/HR <sup>3</sup>	Receiver	Noise Level <sup>4</sup>	System FLA			Weight (lbs)	L x W x H (in)
		Pump (SCFM)	System (SCFM)				208V	230V	460V		
72-21-022A	2	11.0	11.0	5,100	80 Gal.	70	14			736	L = 72.03 W = 27.02 H = 58.39
72-21-022B								13			
72-21-022C									7		

Notes:

<sup>1</sup> Normal Operating conditions at a maximum ambient of 105° F. Consult factory for higher ambient conditions.

<sup>2</sup> Capacities are shown as NFPA system capacities (reserve vacuum pump on standby).

<sup>3</sup> Package BTU/HR are shown with the reserve pump on standby.

<sup>4</sup> Noise levels are shown in dB(A) and reflect one pump running.

**Statement of Warranty**

**Patton's Medical** warrants all Medical Vacuum packages, to be free of defects in material and workmanship under normal use for a period not to exceed thirty (30) months from date of shipment, or twenty-four (24) months from date of start-up.