

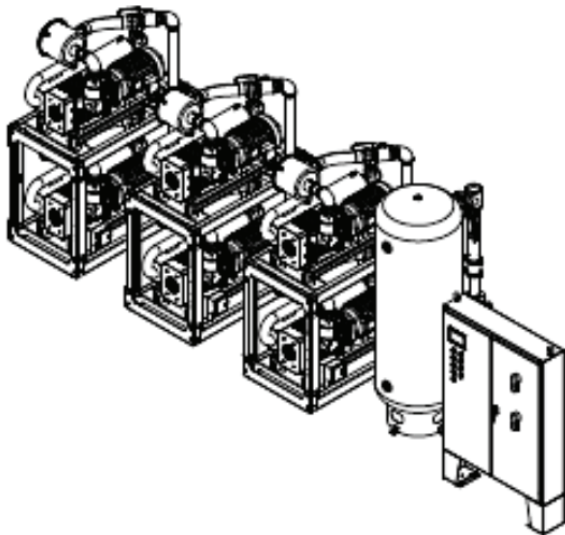

## Rotary Claw Medical Vacuum System

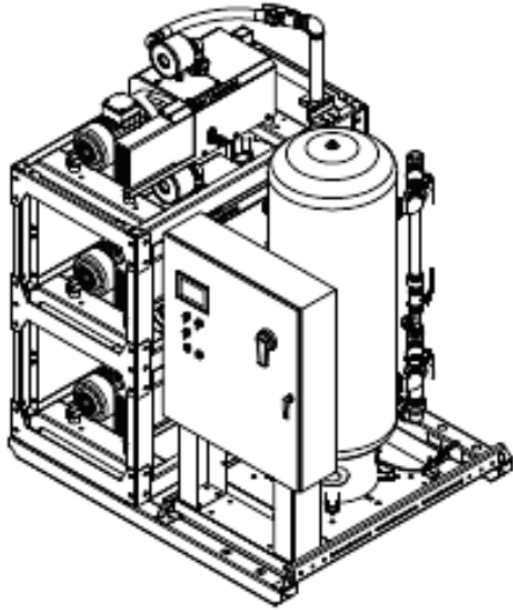

**Installation  
Operation and  
Maintenance  
Manual  
2 - 15 Hp  
With  
Variable  
Frequency  
Drive**



*Oil-Less Rotary Claw Medical Vacuum System*

Model Number:	
Serial Number:	
Date Purchased:	
Purchased from:	

For further technical assistance, service or replacement parts, please contact:

**Patton's Medical**

3201 South Boulevard  
Charlotte, NC 28209

Customer Service: 1-866-960-0087  
Phone: 704-529-5442  
FAX: 704-525-5148

[www.pattonsmmedical.com](http://www.pattonsmmedical.com)

Please include the unit serial number located on the control panel with all inquiries.

Patton's Medical reserves the right to make changes and improvements to update products sold previously without notice or obligation.

Issue Date: May 24, 2012

**Table of Contents****Safety Precautions****1.0 General Information****2.0 Installation**

- 2.1 Inspection Upon Receiving
- 2.2 Handling
- 2.3 Location
- 2.4 Space Requirements
- 2.5 Locations Above Sea Level
- 2.6 Wiring
- 2.7 Intake Piping
- 2.8 Exhaust Piping

**3.0 Control Panel**

- 3.1 *Signal 1* System touch screen gateway
- 3.2 *Signal 1* Main Display Screen
- 3.3 Control Buttons
  - 3.3.1 Menu
  - 3.3.2 Main
  - 3.3.3 Alarm History
  - 3.3.4 History
  - 3.3.5 Vacuum Trend
  - 3.3.6 Vacuum Trend History
  - 3.3.7 Number Pumps Running Trend
  - 3.3.8 Pumps Running History
  - 3.3.9 System Data
  - 3.3.10 Parts Menu
  - 3.3.11 Pump Service
  - 3.3.12 Vacuum Setting
  - 3.3.13 Timer Settings

**4.0 System Operation**

- 4.1 Prestart-up
- 4.2 Initial Start-up
  - 4.2.1 Lubrication
  - 4.2.2 Pump Rotation
- 4.3 Initial Operation
- 4.4 General Operation
  - 4.4.1 Electrical Control Panel
  - 4.4.2 Minimum Run Timers
- 4.5 Tank Drain

(Continued on page 4)

4.6 Emergency Shutdown/Alarms

4.7 Relief Valve

## **5.0 Trouble Shooting**

## **6.0 Maintenance**

6.1 Maintenance Schedule

6.2 General Maintenance for All Units

## **7.0 Inspection/Replacement Procedures**

7.1 Air Intake Filter

7.2 Enclosure Fan Filter Element

## **8.0 Replacement Parts**

## **9.0 Warranty**

## **10.0 Maintenance Record**

## Safety Precautions

The operator should have carefully read and become familiar with the contents of this manual before installing, wiring, starting, operating, adjusting and maintaining the system. The operator is expected to use common sense safety precautions, good workmanship practices and follow any related local safety precautions.

In addition:

- **Before starting any installation or maintenance procedures, disconnect all power to the package.**
- All electrical procedures must be in compliance with all national, state and local codes and requirements.
- A certified electrician should connect all wiring.
- Refer to the electrical wiring diagram provided with the unit before starting any installation or maintenance work.
- Release all vacuum from the package before removing, loosening, or servicing any covers, guards, fittings, connections, or other devices.
- Notify appropriate hospital personnel if repairs or maintenance will affect available vacuum levels.
- Prior to using the Claw Medical Vacuum System, the medical facility must have a certifier perform all installation tests as specified in the latest edition of NFPA 99 and is responsible for ensuring that the Medical Vacuum system meets the minimum requirements as specified in the latest edition of NFPA 99.
- This is a high speed, rotating piece of machinery. Do not attempt to service any part while machine is in operation.
- To prevent automatic starting, disconnect all electrical power before performing any maintenance functions.
- Do not operate unit without guards, shields or screens in place.
- Make sure that all loose articles, packing material, and tools are clear of the package.
- Check all safety devices periodically for proper operation.
- **Do not add lubricating oil of any kind to the pump.**
- The "Hand" mode of operation should only be used for emergencies such as a PLC malfunction and should not be used for normal operation.
- Electrical service must be the same as specified on the control panel nameplate or damage to the equipment may occur.
- Vibration during shipment can loosen electrical terminals, fuse inserts, and mechanical connections. Tighten all electrical connections prior to energizing the control panel.

## **1.0 General Information**

### **System Configurations**

The Claw Medical Vacuum systems are either base mounted or tank mounted units in configurations of duplex, triplex, quadruplex or other multiplexed configurations. All are compliant to the latest edition of the NFPA 99 code and consist of at least two vacuum pumps, two motors, an inlet filter and isolation valve for each pump, an integral pre-wired control panel and air receiver. The systems are constructed as either single point connection (SPC) or modular packages. The complete package is pre-wired, pre-piped, and assembled either on one common base with single point connections for electrical, intake air, discharge air, and condensation drain or as a modular system with connection points for the above.

### **Vacuum Module**

The vacuum pump is an oil-less rotary claw type direct-driven through a shaft coupling. The design is air-cooled, consisting of two claw-type, non-contacting rotors. Sealing fluid is not required. An oil change is required at approximately 5,000 operating hour intervals in the gearbox only. A built-in anti-suckback valve is mounted at the pump inlet and equipped with an inlet filter for removal of particulates.

### **Vacuum Drive and Motor**

The pump is direct driven through a shaft coupling. The motor is a NEMA rated, C-faced TEFC, with 1.15 service factor suitable for 208 or 230/460V electrical service.

### **Intake Piping**

Each vacuum pump has a piped intake with one "hospital type" inlet air filter and threaded opening for remote intake piping. An inlet check valve and isolation valve is piped on each pump. The vacuum pumps are connected to a common manifold and piped to a receiver. A flexible connector is located between each pump and the manifold.

### **Vacuum Receiver**

The vacuum system includes a vacuum receiver vertically or horizontally oriented in the package. The receiver is ASME Code stamped and National Board Certified. The receiver is rated for a minimum 200 psig design pressure and includes an integrally mounted valved bypass, manual drain, and vacuum gauge.

### **Control System**

The mounted and wired control system is NEMA 12 and U.L. labeled. The control system provides automatic lead/lag sequencing with circuit breaker disconnects for each motor. The control panel also includes full voltage motor starters and VFD contactors with overload protection, redundant 120V control circuit transformers, visual and audible reserve unit alarm with isolated contacts for remote alarm, hand-off-auto selector switches, a vacuum indicator, and runtime hours indicator. Automatic alternation of vacuum pumps is based on a first-on/first-off principle with provisions for simultaneous operation if required, automatic activation of the reserve unit if required. Visual and audible alarms indicators for a high discharge temperature shutdown, with isolated contacts for remote alarm, are included.

## 1.0 General Information (Continued)

A **Signal 1 System touch screen gateway** is mounted in the control panel door. It includes:

- a vacuum display
- a runtime display
- a vacuum trend display
- a trend display showing number of pumps running
- an alarm history display
- ability to download trending and history files to PC
- a maintenance schedule and history display
- a service indicator
- a replacement parts display
- a battery backup for history data
- a vacuum set point adjustment display
- a system data display

## 2.0 Installation

### 2.1 Inspection Upon Receiving

The Claw Medical Vacuum system should be carefully inspected upon delivery. Any damage by the carrier should be noted on the delivery receipt, especially if the system will not be immediately uncrated and installed. The system may remain in its shipping container(s) until ready for installation. If the system is to be stored prior to installation, it must be protected from the elements to prevent rust and deterioration.

**DO NOT REMOVE** the protective covers from the inlet and discharge connection ports of the unit until they are ready for connecting to the hospital's pipeline distribution system.

### 2.2 Handling

**!!WARNING!!**

**USE APPROPRIATE LOAD RATED LIFTING EQUIPMENT AND OBSERVE SAFE LIFTING PROCEDURES DURING ALL MOVES.**

The vacuum package can be moved with either a forklift or dollies. Keep all packing in place during installation to minimize damage. If disassembly of the unit is necessary to access doorways or low ceiling clearances, carefully label all electrical connections that are removed for easier re-assembling at the final destination. Units should be placed to ensure easy access to perform maintenance and high visibility of indicators and gauges.

### 2.3 Location

The Medical Vacuum system should be installed indoors in a clean, well-ventilated environment. Areas of excessive dust, dirt or other air-borne particulate should be avoided.

Secure the package to a flat, level surface capable of supporting the weight and forces of the unit. Make sure that the main base is not bowed, twisted, or uneven. Because of the internal flexible hose connections and vibration isolators, **no special foundation is required**. However, the unit base must be securely bolted using all mounting holes provided in the base. If a raised concrete pad is used, the base must not overhang the concrete pad. A method to drain away moisture is necessary. If a gravity drain is not available, a connection to a drain is necessary. After securing the unit to the floor, remove all packing material.

The area should have an ambient temperature of between 40°F and 104°F.

(If the maximum ambient exceeds 104°F, contact the factory for special instructions). The system should be located as close as possible to the point of usage to prevent excessive loss of operating vacuum due to pressure drop.



## 2.0 Installation (Continued)

### 2.4 Space Requirements

The Medical Vacuum system should be placed to ensure easy access to perform maintenance and high visibility of indicators and gauges. It is recommended that a minimum space of 24" be allowed on all sides of the compressor system for ventilation and maintenance. A minimum space of 36" in front of the control panel is required by NEC code. A vertical distance of 36" is required above the unit for ventilation and maintenance.

### 2.5 Locations Above Sea Level

All vacuum pumps above sea level have reduced flow and should be de-rated. After determining the correct flow needed for the medical vacuum system, multiple this number by the adjustment factor in the following chart. After determining the new flow required, use this number to size the medical vacuum system.

Altitude Adjustment Factor		
Altitude (ft)	Normal Barometric Pressure (inches HG)	Multiplier Used for Required SCFM
0	29.92	1.00
500	29.39	1.02
1000	28.86	1.04
1500	28.33	1.06
2000	27.82	1.08
2500	27.32	1.10
3000	26.82	1.12
3500	26.33	1.14
4000	25.84	1.16
<b>&gt;4000</b>	<b>Do NOT use Oil-less Vacuum Pumps. Contact Factory.</b>	

## 2.0 Installation (Continued)

### 2.6 Wiring

#### **WARNING!**

**BE SURE TO DISCONNECT ALL ELECTRICAL POWER TO THE VACUUM SYSTEM BEFORE PERFORMING ANY ELECTRICAL PROCEDURES.**

**Refer to the electrical diagram provided with the unit before starting any installation or maintenance work.**

**Do not operate the vacuum system on a voltage other than the voltage specified on the system's nameplate.**

**All customer wiring should be in compliance with the National Electrical Code and any other applicable state or local codes.**

**Electrical power for the Medical Vacuum system must be supplied from the emergency life support circuit.**

Check the control voltage, phase and amp ratings before starting the electrical installation, and make sure the voltage supplied by the hospital is the same.

The wire size should be able to handle peak motor amp load of all operating units, refer to the full load amperes on the wiring diagram.

Check all electrical connections within the vacuum system that may have loosened during shipment.

Only qualified electricians should make power connections to the control panel and any interconnecting wiring.

Ensure that the emergency generator system's electrical supply is consistent with the vacuum system's requirements.

Three-phase power supplied from the emergency generator(s) must match that of the normal supply to allow for correct direction of the motor rotation at all times.

## 2.0 Installation (Continued)

### 2.7 Intake Piping

Before connecting any piping, the plastic thread protector installed in the connection port must be removed. The main vacuum line to the receiver should not be reduced below that provided on the receiver. Long piping runs may need to be increased in size to minimize pressure drop. Improper line sizing may result in a loss of capacity. Ideally, piping should be constructed using long radius elbows and a minimum number of turns. All secondary lines should be taken from the top or side of the main line to prevent any accumulated moisture from draining towards the pumps. All lines should slope away from the pumps. Any low points in the piping should be equipped with pipe drains to remove accumulated moisture. All intake vacuum lines must be piped to in accordance with NFPA 99. All pipe must be either seamless copper tubing or other corrosion-resistant metallic tubing, such as galvanized steel or stainless steel, as detailed in NFPA 99.

### 2.8 Exhaust Piping

The exhaust line must be piped outside of the building in accordance with NFPA 99. To ensure that no restriction of airflow will occur, size the piping according to the following chart. All pipe must be either seamless copper tubing or other corrosion-resistant metallic tubing, such as galvanized steel or stainless steel, as detailed in NFPA 99. A flexible connector (shipped loose) must be installed on each exhaust port of the vacuum pump before connecting to the main exhaust line leading outdoors. Additionally, a drip leg must be installed at each exhaust port connection to allow for the draining of any accumulated moisture (Refer to the installation schematics for more details). The outside pipe must be turned down and screened to prevent contamination.

#### **WARNING:**

**The vacuum exhaust vent must be located away from medical air intakes, doors and openings in the buildings to minimize possible contamination to the facility, in accordance with NFPA 99.**

## 2.0 Installation (Continued)

### 2.8 Exhaust Piping (Continued)

#### Minimum Pipe Sizes

- Notes:**
1. All pipe sizes are based on the following: copper pipe (Type L), 14.7 psia.
  2. The minimum pipe size must be maintained for the total length of the exhaust pipe. Use next larger size pipe in the event the minimum size is not available.
  3. When determining the total pipe length, add all the straight lengths of pipe together in addition to the number of elbows times the effective pipe length for that pipe size. (See the table and example below.)

**Example:**

Select the pipe size for a Duplex 6.4 HP with 100 feet of straight pipe and four elbows:

- A) Select the pipe size of 4" diameter for 100 feet of straight pipe.
- B) Determine the eff. pipe length for an elbow of 4" diameter (EPL = 10.0 ft / elbow).
- C) Calculate the SYSTEM PIPE LENGTH {SPL (4.0" D) = 100 + (4 x 10.0) = 140 ft
- D) Check this SYSTEM PIPE LENGTH to see if it exceeds the minimum pipe size.

Vacuum System	System Pipe Length (ft) - See Notes											
	25	50	75	100	150	200	250	300	350	400	450	500
Duplex 2 HP	1.25	1.25	1.25	1.25	1.50	2.00	2.00	2.00	2.00	2.00	2.00	2.00
Duplex 3 HP	1.50	1.50	1.50	1.50	2.00	2.00	2.00	2.00	2.00	2.00	2.00	2.00
Duplex 4 HP	2.00	2.00	2.00	2.00	2.00	2.50	2.50	3.00	3.00	3.00	3.00	3.00
Duplex 5.4 HP	2.00	2.00	2.00	2.00	2.00	2.50	3.00	3.00	3.00	3.00	3.00	3.00
Duplex 6.4 HP	3.00	3.00	3.00	4.00	4.00	4.00	4.00	4.00	4.00	4.00	4.00	4.00
Duplex 7.5 HP	3.00	3.00	3.00	4.00	4.00	4.00	4.00	4.00	4.00	4.00	4.00	4.00
Duplex 8.7 HP	3.00	3.00	3.00	4.00	4.00	4.00	4.00	4.00	4.00	4.00	4.00	4.00
Duplex 10 HP	3.00	3.00	3.00	4.00	4.00	4.00	4.00	4.00	4.00	4.00	5.00	5.00
Duplex 15 HP	3.00	3.00	4.00	4.00	4.00	4.00	5.00	5.00	5.00	5.00	5.00	5.00
Triplex 5.4 HP	2.00	2.00	2.00	3.00	3.00	3.00	3.00	3.00	4.00	4.00	4.00	4.00
Triplex 6.4 HP	3.00	3.00	3.00	4.00	4.00	4.00	4.00	4.00	4.00	5.00	5.00	5.00
Triplex 7.5 HP	3.00	3.00	3.00	4.00	4.00	4.00	4.00	4.00	4.00	5.00	5.00	5.00
Triplex 8.7 HP	4.00	4.00	4.00	4.00	4.00	5.00	5.00	5.00	5.00	5.00	5.00	5.00
Triplex 10 HP	4.00	4.00	4.00	4.00	4.00	5.00	5.00	5.00	5.00	5.00	5.00	5.00
Triplex 15 HP	4.00	4.00	4.00	4.00	5.00	5.00	5.00	5.00	6.00	6.00	6.00	6.00
Quad 5.4 HP	3.00	3.00	3.00	3.00	3.00	3.00	4.00	4.00	4.00	4.00	4.00	4.00
Quad 6.4 HP	3.00	4.00	4.00	4.00	4.00	4.00	4.00	5.00	5.00	5.00	5.00	5.00
Quad 7.5 HP	3.00	4.00	4.00	4.00	4.00	4.00	4.00	5.00	5.00	5.00	5.00	5.00
Quad 8.7 HP	4.00	4.00	4.00	5.00	5.00	5.00	5.00	5.00	6.00	6.00	6.00	6.00
Quad 10 HP	4.00	4.00	4.00	5.00	5.00	5.00	5.00	5.00	6.00	6.00	6.00	6.00
Quad 15 HP	4.00	4.00	5.00	5.00	5.00	6.00	6.00	6.00	6.00	6.00	6.00	6.00

Effective Pipe Length Equivalent of a 90 Degree Elbow										
Pipe Size (in.)	1.50	2.00	2.50	3.00	3.50	4.00	5.00	6.00	8.00	
Eff. Pipe Length (ft)	3.6	4.9	6.4	7.9	9.4	10.0	11.9	13.2	14.5	

## 3.0 Control Panel

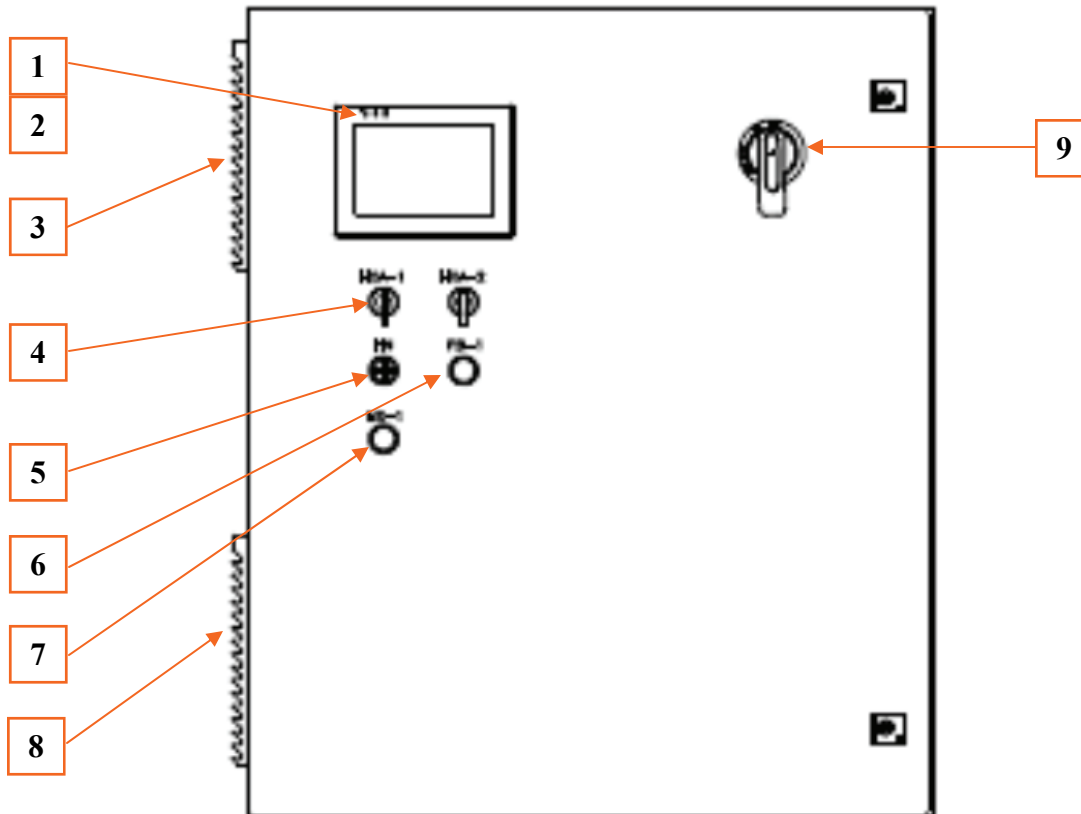

1. **Display Screen** – Displays the systems operating screens
2. **LED's** –Yellow PWR: Power is correctly supplied  
 Green CPU: Indicates the Signal 1 is operating correctly  
 Red COM: Indicates communication with PLC  
 Not lighted: Power is not supplied
3. **Enclosure Cooling Fan** – Remove heat from enclosure
4. **HOA selector switch** – Compressor control switch, Hand – Off – Auto
5. **Alarm horn** – Sounds when an alarm condition occurs
6. **Alarm Reset/Horn Silence** – Pushbutton to silence alarm and reset visual alarm on *Signal 1* screen after alarm condition is corrected
7. **Motion sensor**– Turns Signal 1 back light on if movement is present
8. **Enclosure Cooling Vents** – Removes heat from enclosure
9. **External Operator** – Turns Main Disconnect On - Off

## 3.0 Control Panel (Continued)

### 3.1 Signal 1 System touch screen gateway

The Scroll Medical Air system has a touch screen gateway to control and monitor the complete system operation as well as record service and alarm history of the unit and change pressure setting levels.

**3.2 Signal 1 Main Display Screen** The main screen for systems will monitor and display the air receiver vacuum level, motor speed, run sequence, individual unit total run hours and run status (HOA switch position). Included on this screen is a service due alarm, transducer fault alarms and lag alarm for the system as well as individual alarms for each compressor unit (motor overload, and high discharge air temperature) . The “MENU” button in the upper right corner will allow the operator to navigate through the screens to view the system alarm history, service schedule and records, and vacuum trends, basic troubleshooting, vacuum settings, and system general information. When the *Signal 1* is powered up the main control window will appear on the display screen. This screen displays the systems current vacuum level, total hours run for each module, run sequence, HOA switch setting and status of service schedule and alarm conditions.

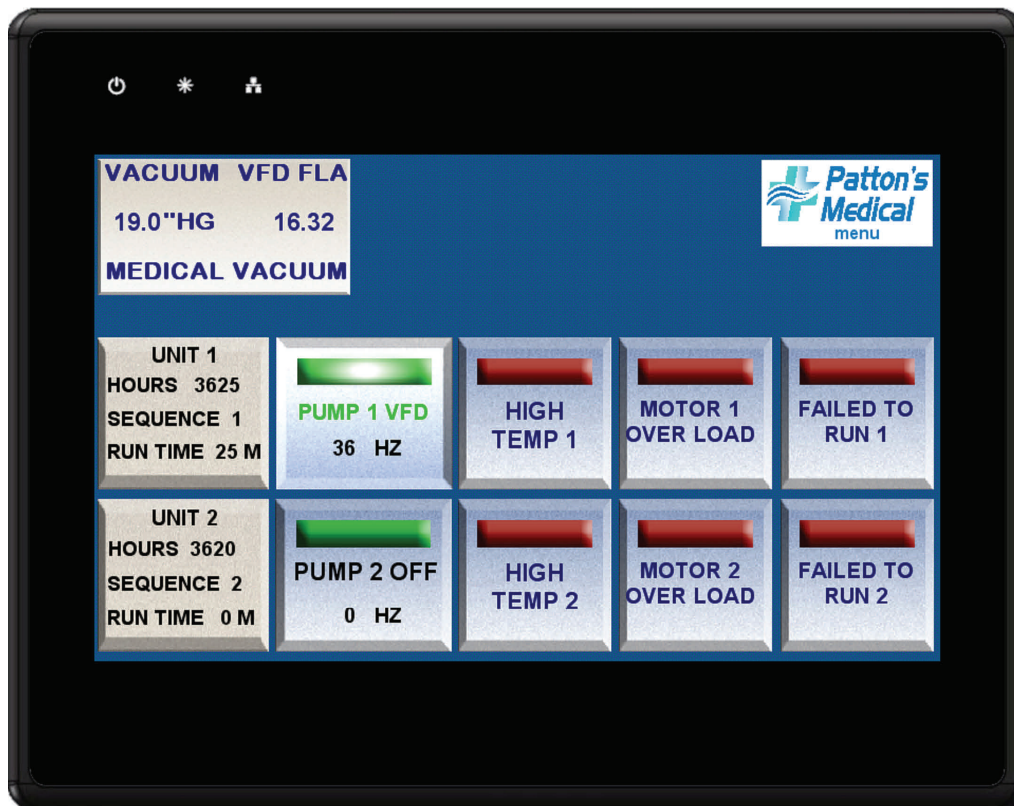

3.2. Main Panel Screen (Duplex System shown)

### 3.0 Control Panel (Continued)

#### 3.2 HMI Main Display Screen (Continued)

1. MENU: Displays menu screen which allows the operator to access the systems operating history, service requirements, and vacuum trends, troubleshooting info and main system info.
2. VACUUM (inches Hg): Display's the current vacuum level inside the air receiver.
3. SERVICE DUE: Service intervals and types of service are preprogrammed into the HMI. The button will flash yellow when service is due. Pressing the "service due" button when flashing will display the service schedule screen.
4. TDC FAULT: Indicator will flash red and horn will sound if the transducer fails. Vacuum reading on the display screen will default to "30" hg. Selecting the indicator when flashing red will open a trouble shooting window.
5. LAG ALARM: Indicator will flash red and horn will sound when last available vacuum unit comes on. Press the reset button to silence the alarm. If the condition is corrected both the alarm and indicator will turn off. If a lag condition remains the indicating light on the HMI will remain on. Selecting the indicator when flashing red will open a trouble shooting window. Once the lag condition is corrected, press the reset button again to turn off alarm light.
6. UNIT RUN HOURS: Displays total run hours for each vacuum module.
7. HAND-OFF-AUTO: Displays status of each vacuum module. The green "HAND" displays when the vacuum is running and the HOA selector switch is in the HAND setting. The green "AUTO" displays when the vacuum is running in the bypass (60 Hz) mode and the HOA selector switch is in the AUTO position. The green "VFD ON" displays when a pump is running in the VFD mode. The "OFF" indicator is displayed when the HOA selector switch is in the "OFF" position for the pump that is not running.
8. MOTOR OVLD: Display will flash red and sound an alarm when overload switch is tripped in the control panel. The vacuum in question will not re-start until the reset button on the starter inside the main control cabinet is reset. Press the reset button on front panel to silence the alarm. Selecting the indicator when flashing red will open a trouble shooting window. The indicator on the HMI will remain on until motor starter is reset.
9. FAILED START: Display will flash red if the vacuum module failed to start/run when signaled to start. This alarm will also activate when a Motor Overload Shutdown occurs. Press the reset button on the front panel to silence the alarm. Selecting the indicator when flashing red will open a trouble shooting window. The indicator light on the HMI will remain on until the problem has been resolved and the reset button pushed again.
10. VFD OVERLOAD: Displays if a VFD motor overload occurs. VFD will be disabled and system will run in a non-VFD condition. VFD can be reset by pressing the reset button on the front of the control panel.

## 3.0 Control Panel (Continued)

### 3.3 Control Buttons

#### 3.3.1 MENU

The MENU button in the upper right corner on the main screen when selected will display the “MENU” window that will allow the operator to access information shown on screen below. Each button will be explained in detail in this section.

#### 3.3.2 – “MAIN” Button

The main button can be found on many of the screens within the *Signal 1* Controller. At any time when the “MAIN” button is selected, the *Signal 1* display will return to the Main Display Screen.





## 3.0 Control Panel (Continued)

### 3.3 Control Buttons (Continued)

#### 3.3.3 – “ALARM HISTORY” Button

The “ALARM HISTORY” button on the “Menu” screen will open a new window listing all the alarm conditions that have occurred as well as routine maintenance alerts. The list will show the date and time of the incident, type of incident and when the condition was cleared/corrected. This creates a permanent record of the history of the unit and cannot be reset.

1. “MAIN” button will return you to the main screen.
2. “HISTORY” button will open a new History screen shown on the next page

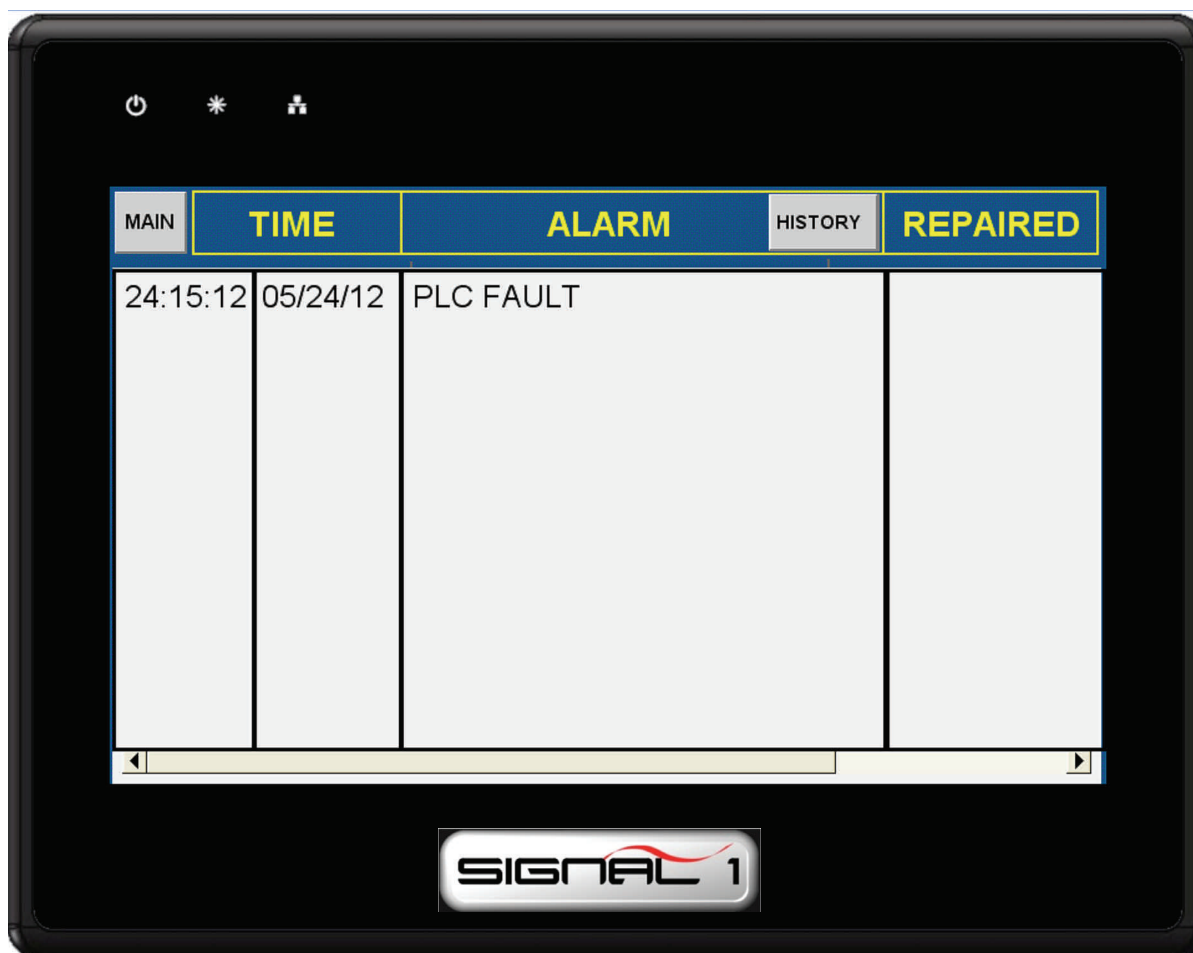

## 3.0 Control Panel (Continued)

### 3.3 Control Buttons (Continued)

3.3.4 – “HISTORY” screen displayed from pressing “History” button on “Alarm History” screen shown below. Pressing the up and down arrows will display alarm/maintenance history one day at a time. History can be down loaded to a USB memory stick by inserting the memory stick into the USB slot on the back of the *Signal 1* and pressing the “Download To USB” button on the screen. Files can be saved to PC and viewed in an excel format.

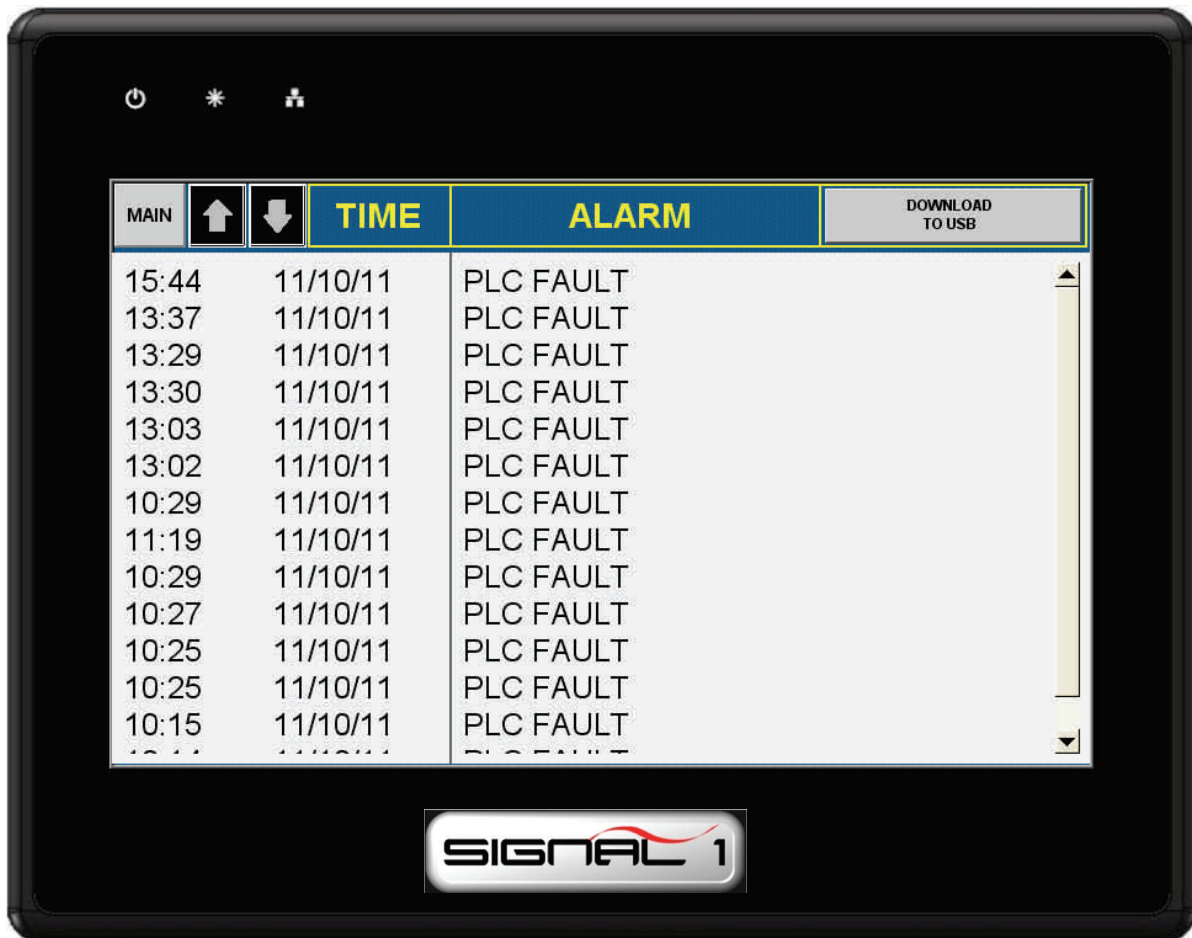

## 3.0 Control Panel (Continued)

### 3.3 Control Buttons (Continued)

**3.3.5 – “VACUUM TREND”** Pressing the “Vacuum Trend” button on the “Menu” screen will display the screen below. Screen displays 15 minutes of trending and has a scroll bar on the bottom of screen to scroll to different time frame.

1. “MAIN” button will return you to the main screen.
2. “SYSTEM PRESSURE HISTORY” button will open a new screen shown on the next page

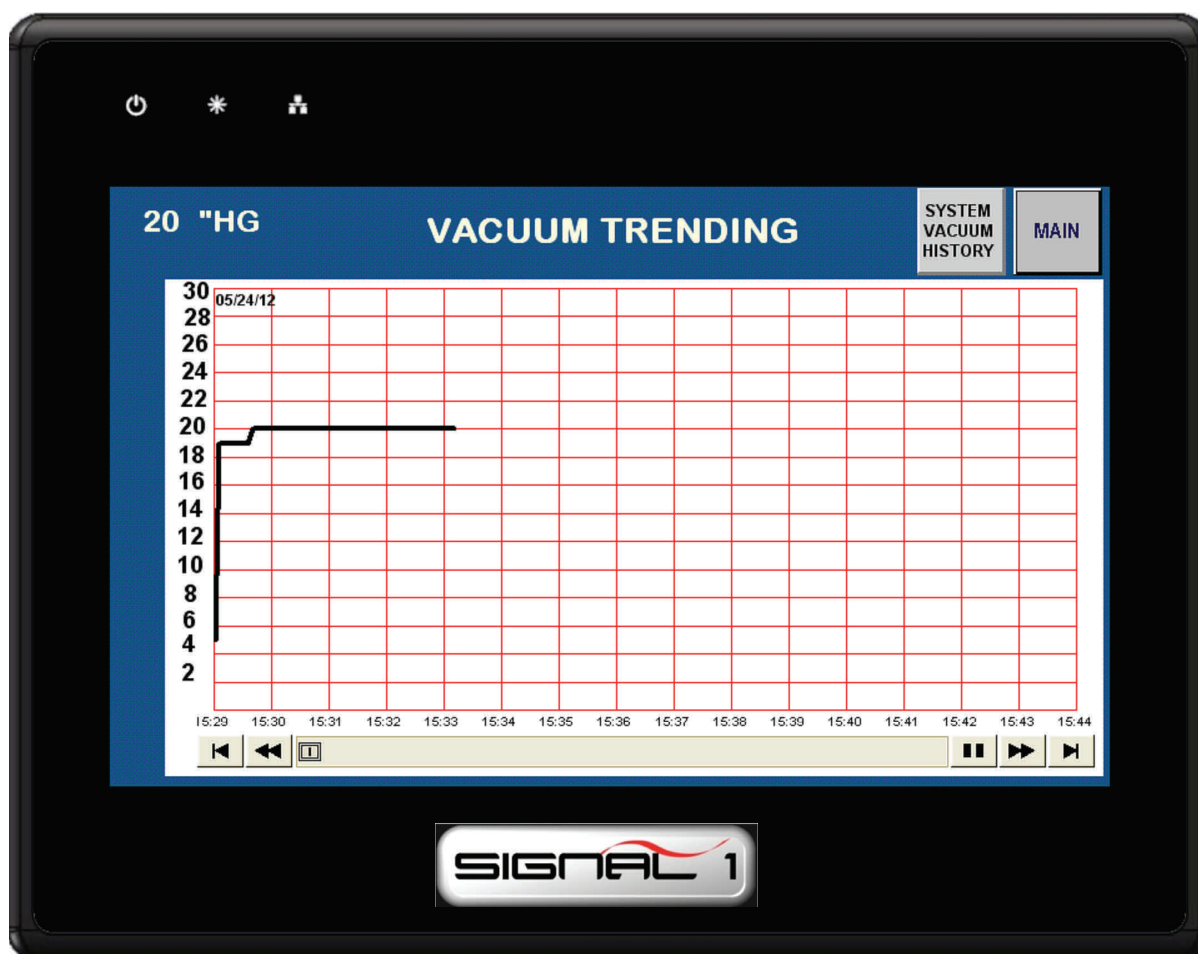

## 3.0 Control Panel (Continued)

### 3.3 Control Buttons (Continued)

3.3.6 – “VACUUM TREND HISTORY” screen shown below. Pressing the up and down arrows will display pressure trending history one day at a time. History can be down loaded to a USB memory stick by inserting the memory stick into the USB slot on the back of the *Signal 1* and pressing the “Download To USB” button on the screen. Files can be saved to PC and viewed in an excel format.

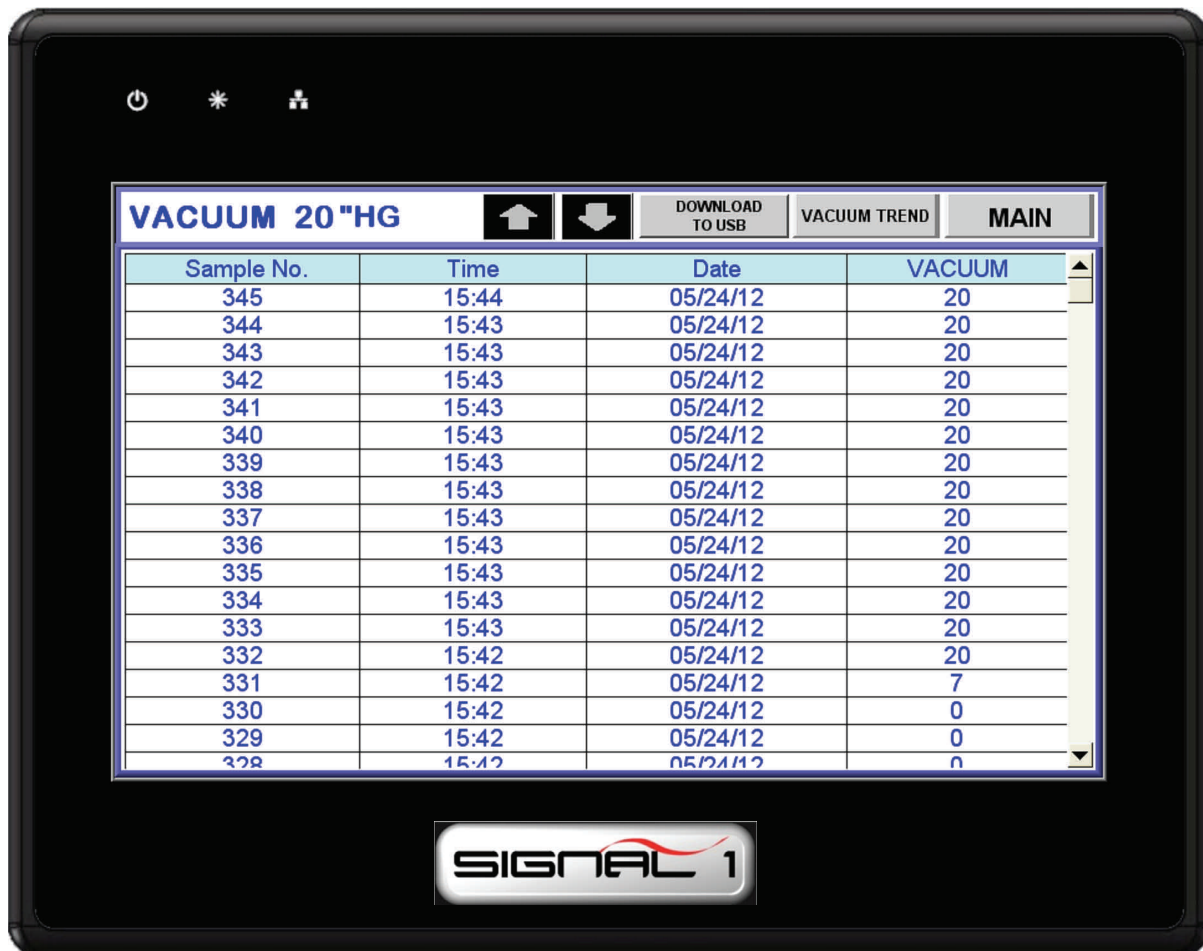

## 3.0 Control Panel (Continued)

### 3.3 Control Buttons (Continued)

**3.3.7 – “NUMBER PUMPS RUNNING TREND”** Pressing the “NUMBER PUMPS RUNNING TREND” button on the “Menu” screen will display the screen below. Screen displays 15 minutes of trending and has a scroll bar on the bottom of screen to scroll to different time frames.

1. “MAIN” button will return you to the main screen.
2. “PUMPS RUNNING HISTORY” button will open a new screen shown on the next page

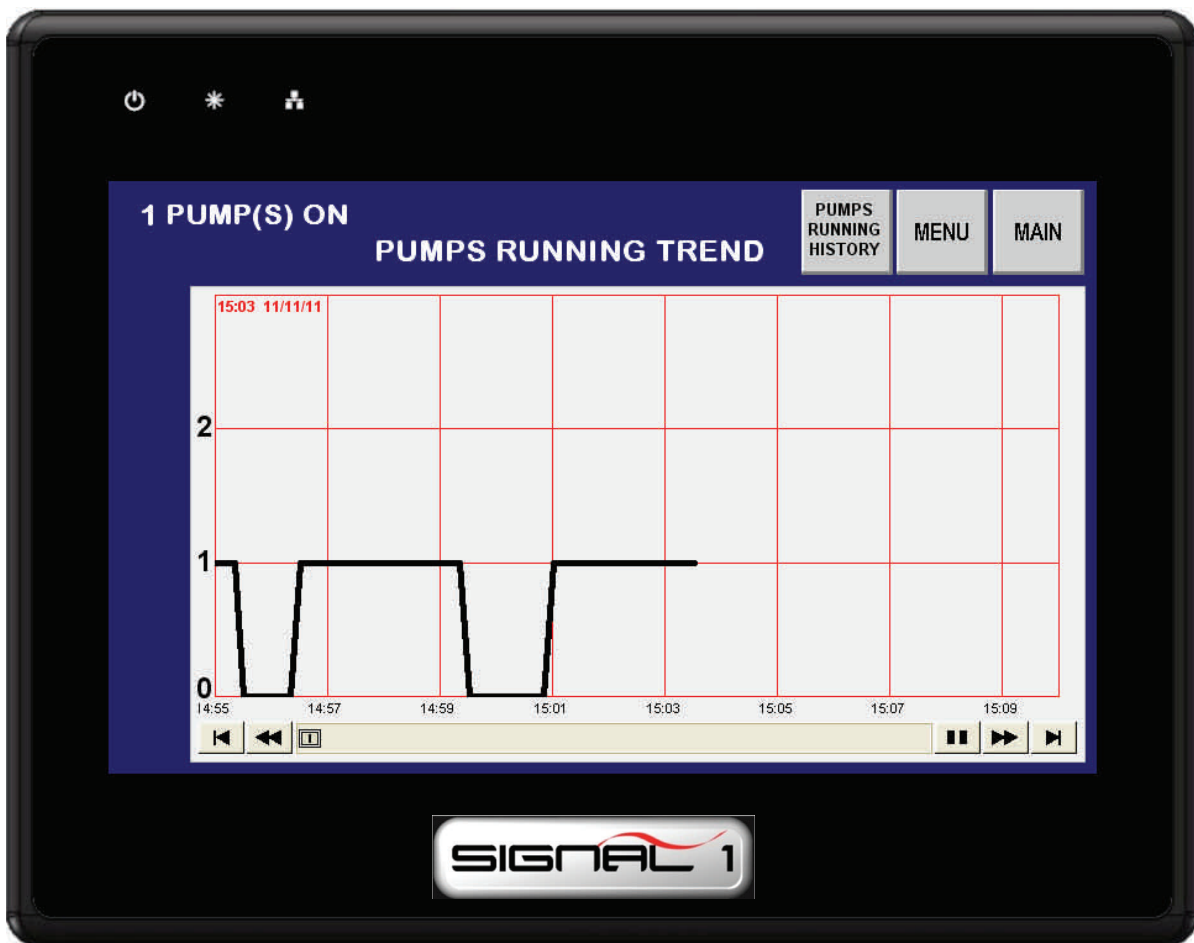

## 3.0 Control Panel (Continued)

### 3.3 Control Buttons (Continued)

3.3.8 – “PUMPS RUNNING HISTORY” screen shown below. Pressing the up and down arrows will display number of pumps running trending history one day at a time. History can be downloaded to a USB memory stick by inserting the memory stick into the USB slot on the back of the *Signal 1* and pressing the “Download To USB” button on the screen. Files can be saved to PC and viewed in an excel format.

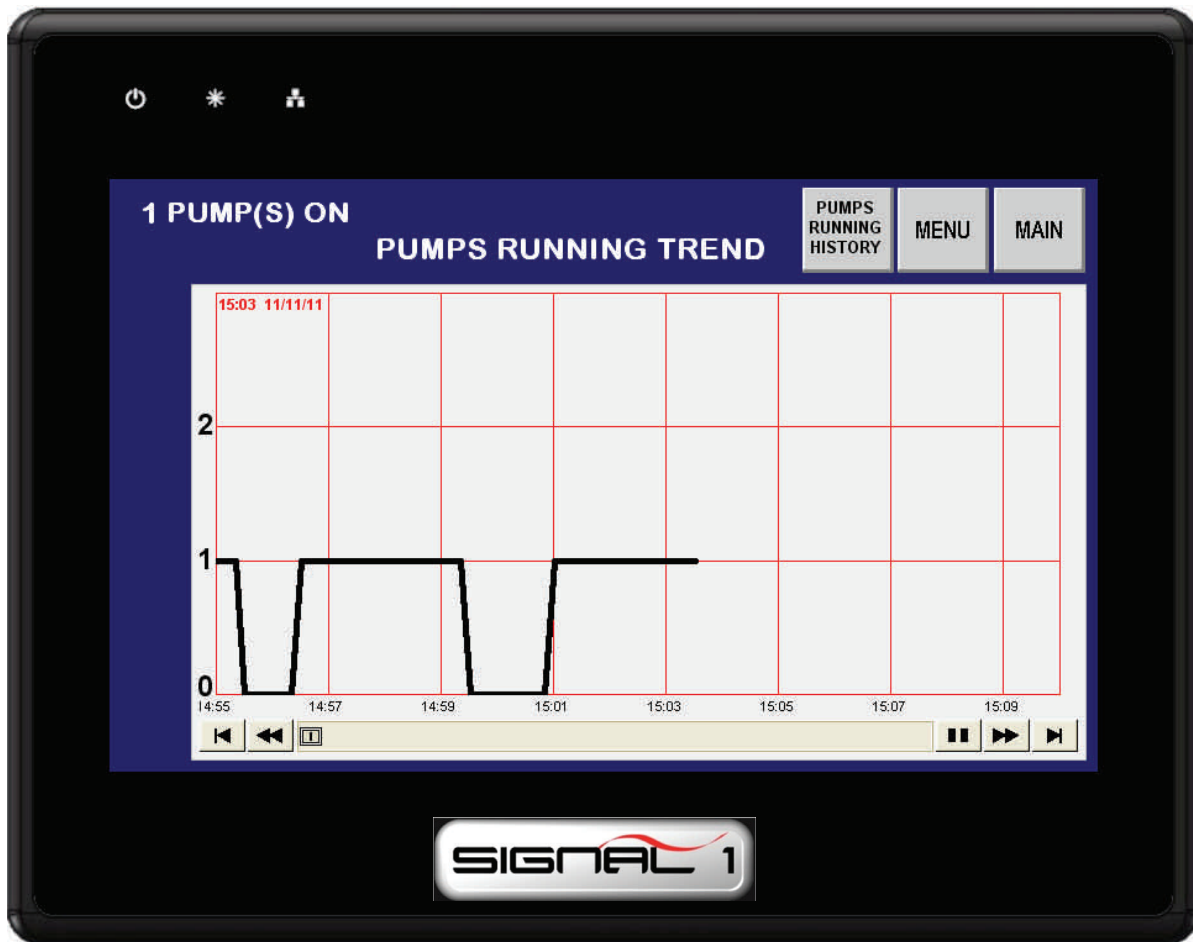

## 3.0 Control Panel (Continued)

### 3.3 Control Buttons (Continued)

#### 3.3.9 “SYSTEM DATA” Button

The “System Data” button displays all the system information required when scheduling maintenance or purchasing spare parts from Patton’s Medical. The information includes model number, serial number, horsepower, system voltage, and unit start up date. This information will be programmed into the *Signal 1* at startup by a Patton’s Medical authorized technician.

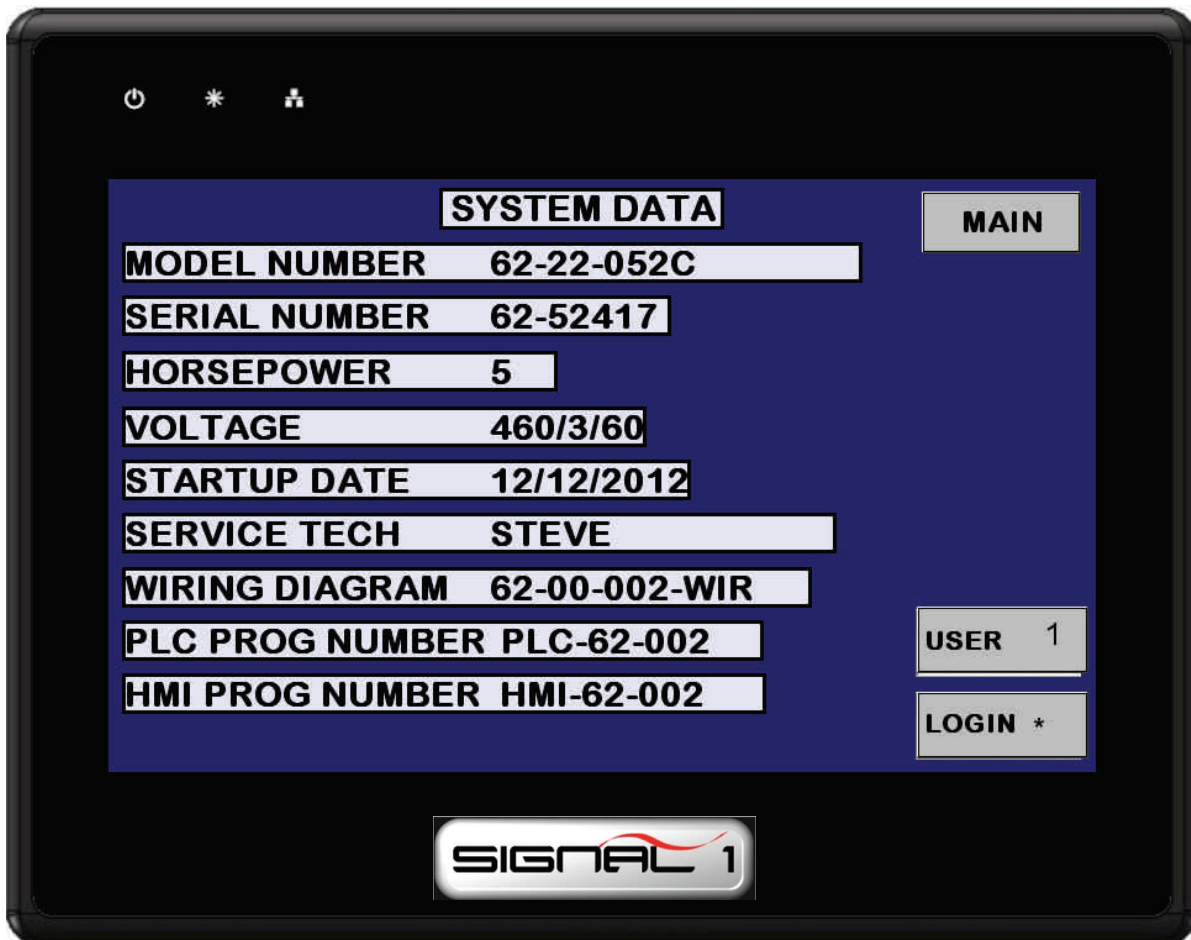

## 3.0 Control Panel (Continued)

### 3.3 Control Buttons (Continued)

#### 3.3.10 “PARTS MENU” Button

The “Parts Menu” button displays routine maintenance parts required when performing scheduled maintenance.

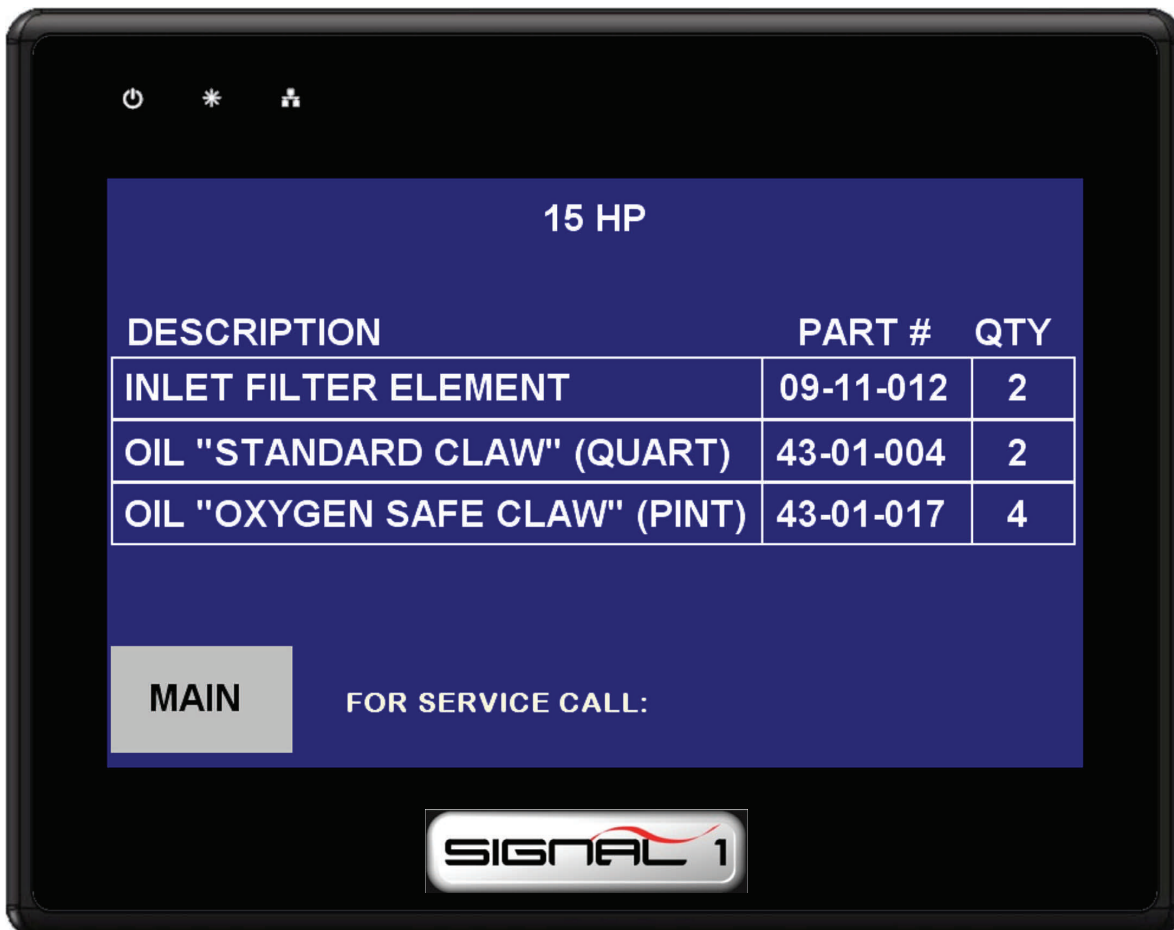



## 3.0 Control Panel (Continued)

### 3.3 Control Buttons (Continued)

#### 3.3.11 – “PUMP SERVICE” Buttons

1. Select “USER #” button and enter “3” and press “enter”.
2. Select “LOGIN” button and enter “350” and press “enter”.
3. Press “RESET” button next to item requiring maintenance red light will be flashing.

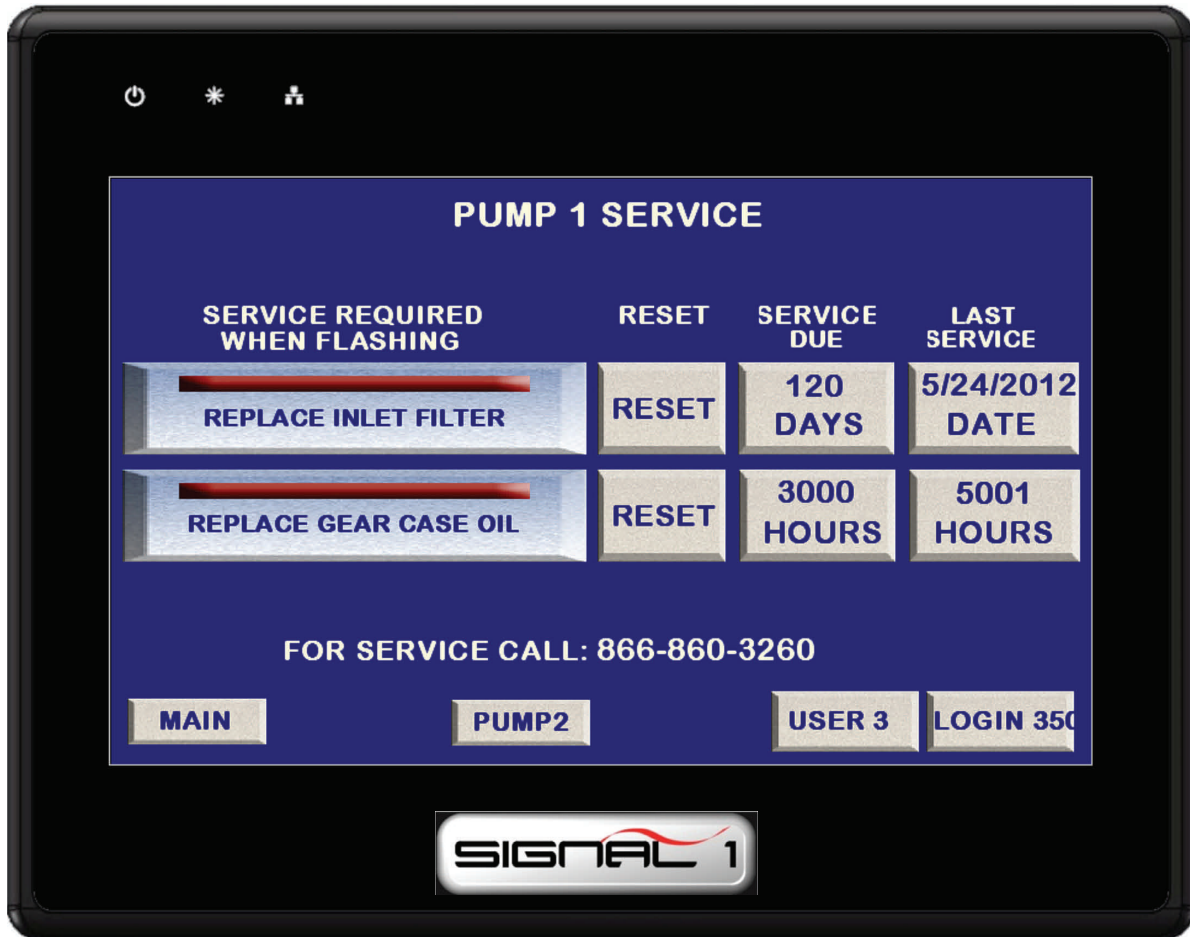

4. Screen to right will display press “YES” to reset maintenance performed. Service due date and Last Service date will reset.

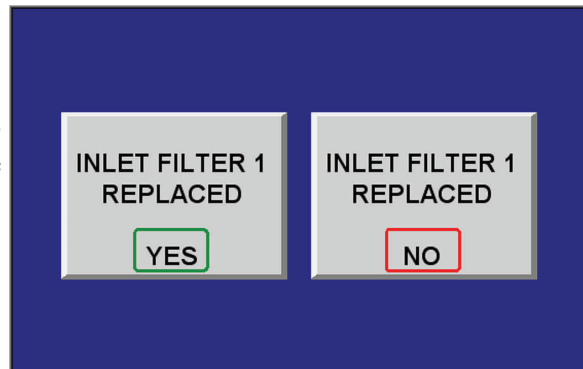

## 3.0 Control Panel (Continued)

### 3.3 Control Buttons (Continued)

#### 3.3.12 – “VACUUM SETTINGS” Buttons

1. Select “USER #” button and enter “3” and press “enter”.
2. Select “LOGIN” button and enter “350” and press “enter”.
3. Press up or down arrow to increase or decrease vacuum setting, actual vacuum level will also be displayed.
4. Press “Timer Settings” button to change to minimum run time setting screen seen on next page.

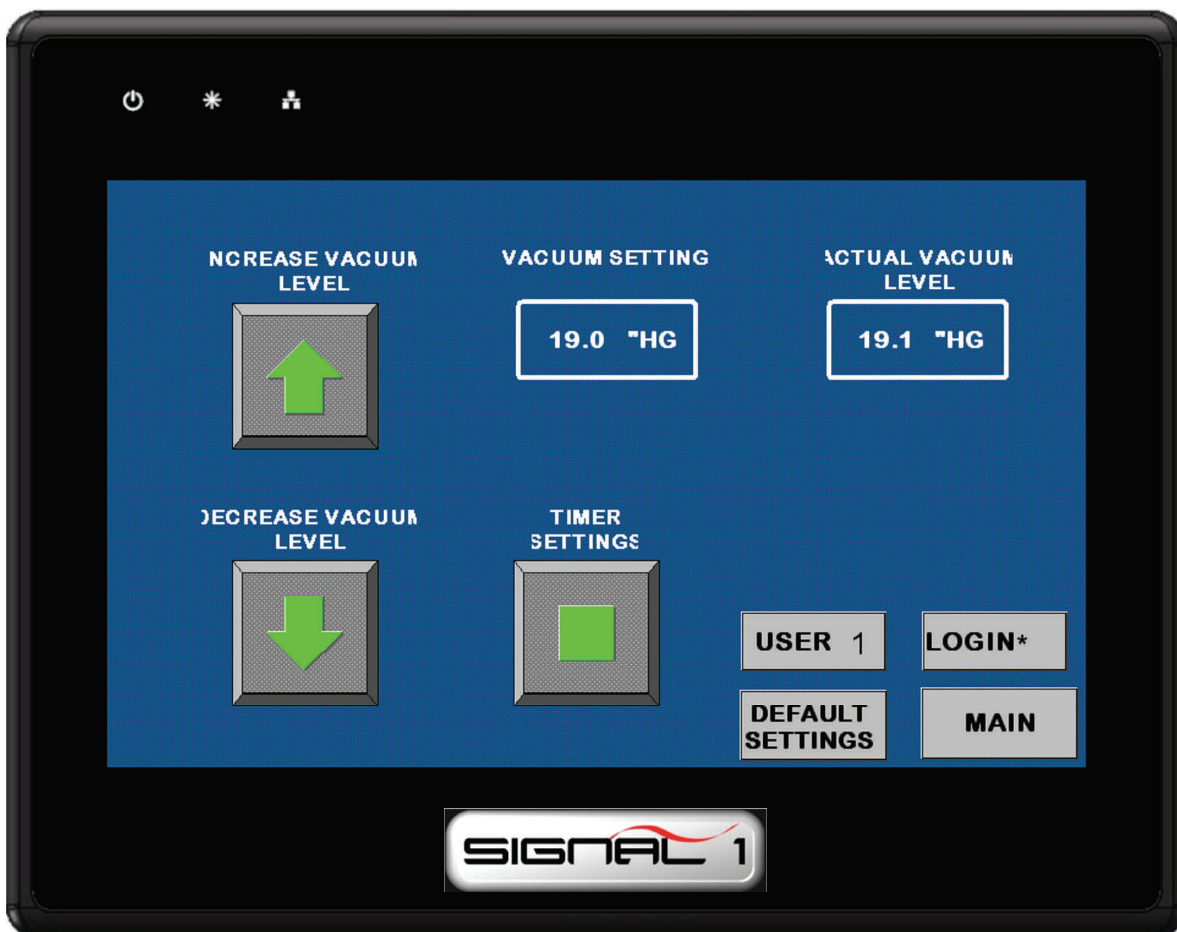

## 3.0 Control Panel (Continued)

### 3.3 Control Buttons (Continued)

#### 3.3.13 – “TIMER SETTINGS” Buttons

1. Select “USER #” button and enter “3” and press “enter”.
2. Select “LOGIN” button and enter “350” and press “enter”.
3. Press minimum run timer setting desired at bottom of page, If demand is consistent and 1 pump runs most of the time a longer time setting may be more desirable.
4. Consult factory before making adjustments to any setting other than minimum run timer settings.

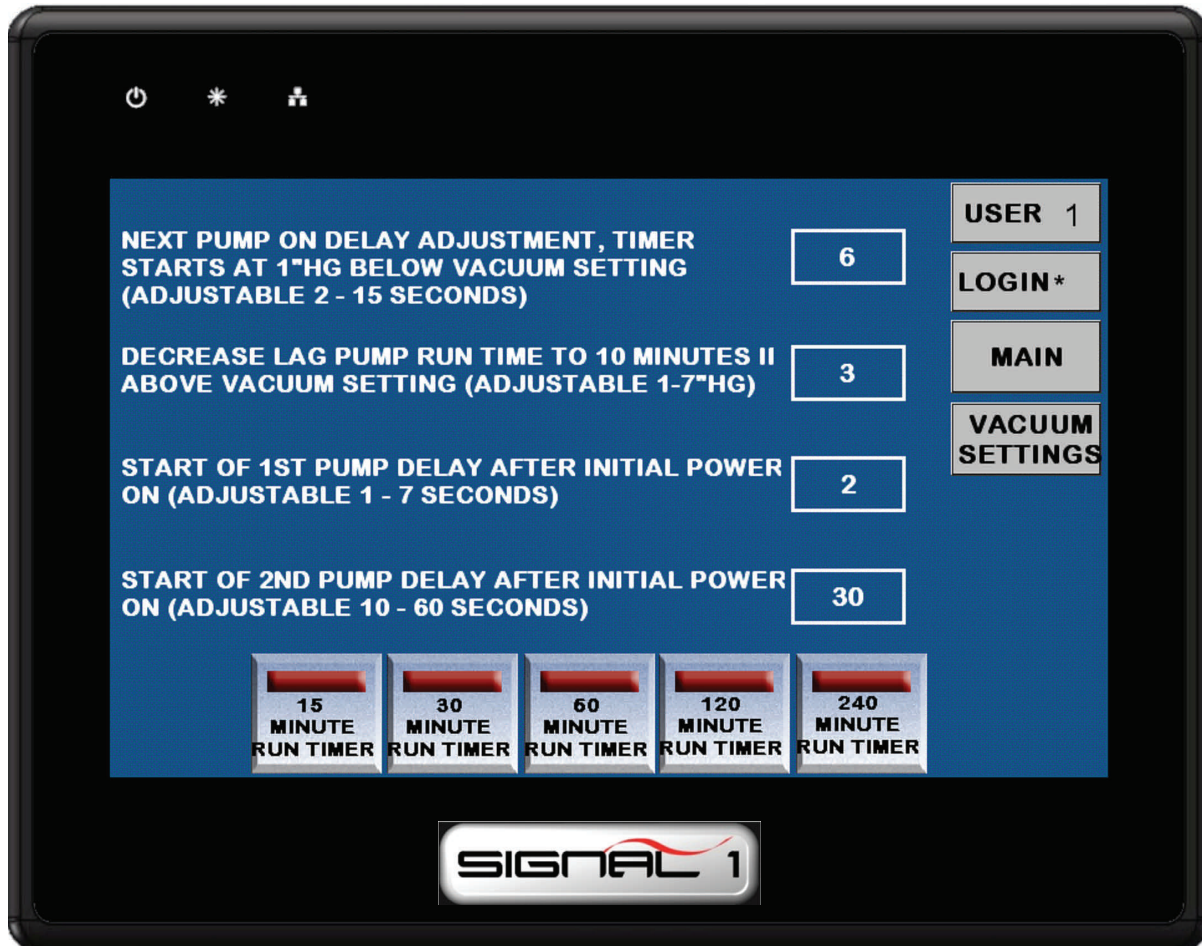

## 4.0 System Operation

### 4.1 Pre-start-up

The contractor should notify **Patton's Medical** two weeks prior to start-up date to schedule an appointment for an authorized technician to review the installation prior to start-up.

**WARNING:**

**Prior to putting the Medical Vacuum system into use, the medical facility must have a Certifier perform all installation tests as specified in NFPA 99. The medical facility is also responsible for ensuring that the Medical Vacuum meets the minimum requirements for Medical Vacuum as specified in NFPA 99.**

**CAUTION:** Failure to install the unit properly and have an authorized technician from **Patton's Medical** start-up the system can void the manufacturer's warranties.

**WARNING:**

**Have more than one person on hand during prestart-up and start-up procedures to ensure safety and to facilitate certain checks.**

Prestart-up and start-up procedures should be performed for a new installation or when major maintenance has been performed.

The main power source to the control panel should be OFF for the duration of the visual inspection.

Ensure that the equipment is installed on a solid level surface. Walk around the system to ensure that there is enough clearance on all sides to perform operational checks/actions and maintenance. The temperature of the area containing the modules should be approximately 70°F (21.1°C) with a minimum ambient temperature of 40°F (4.4°C) and a maximum ambient temperature of 104°F (40°C).

Check the inlet piping for proper size and connection to the vacuum system.

Check all piping system joints that might have come loose during shipment and installation to ensure they are tight.

Check the vacuum receiver, controls, and vacuum pumps for damage.

Check the drain valves on the receiver.

## 4.0 System Operation (Continued)

### 4.1 Prestart-up (Continued)

Check all valves for full open and full close travel. Ensure that the system's valves are positioned for proper operation. (Refer to indicators on the valve handles.)

#### **Remove all packing material from the unit.**

Check the electrical connections to the control cabinet.

Verify electrical service. Before starting the Medical Vacuum system, check to see that voltage, amperage, and wire size are appropriate.

**CAUTION:** Electrical service must be as specified or damage to equipment may occur.

#### **WARNING:**

**To prevent electrical shock, ensure that ALL electrical power to the system is OFF, including the disconnect switches and H-O-A switches on the control panel. The facility's supply circuit breaker should also be locked out.**

Open the electrical cabinet by loosening the fasteners on the front.

**CAUTION:** Vibration during shipment and installation can loosen electrical terminals, fuse inserts, and mechanical connections. Tighten as necessary.

Check the electrical cabinet for any broken switches, lights, etc.

Check that all motor starter connections are tight and that there are no loose objects such as terminal lugs, screws, nuts, etc., in the cabinet.

## 4.0 System Operation (Continued)

### 4.2 Initial Start-up

**CAUTION:** Complete the prestart-up procedure before continuing with the initial start-up procedure

**WARNING:**

**To prevent electrical shock, ensure that ALL electrical power to the system is OFF, including the disconnect switches and H-O-A switches on the control panel. The facility's supply circuit breaker should also be locked out.**

#### 4.2.1 Lubrication

The pump's synchronizing gears are oil lubricated, but **there is no lubricant or sealing fluid inside the pumping chamber**. All Claw vacuum pumps are shipped with the required amount of oil for start-up already in the pumps. The level should be slightly above the middle of the sight glass.

**NOTE: DO NOT ADD OIL TO THE VACUUM PUMP.**

**WARNING:**

**Ensure that all loose articles, packing material, and tools are clear of the system.**

Set the H-O-A switches are to "O" (OFF).

Check all voltages supplied to the system to ensure they are the required value and phases needed by the control panel.

Open the inlet isolation valve on each vacuum pump.

Open the outlet isolation valve on each vacuum pump.

Open the receiver isolation valves.

Close the receiver bypass valve.

Apply power to the system and turn the disconnect switches to "On".

## 4.0 System Operation (Continued)

### 4.2 Initial Start-up (Continued)

#### 4.2.2 Pump Rotation

Prior to actual operation, the pumps must be checked for correct rotation.

Using the Hand-Off-Auto switch on the door of the control panel, jog the motor of the specific pump that is to be checked by momentarily turning the switch to "Hand" and back to "Off". By observing the cooling fan of the motor, you can determine the rotation of the pump. Pump rotation should be counterclockwise when looking at the rear of the motor. Directional arrows are located on each pump.

If the pumps are rotating in the wrong direction, rotation can be reversed by switching any two main power leads to the panel. Correct rotation should be confirmed in the previous manner.

**WARNING:**

**REMOVE POWER BEFORE WORKING ON ANY ELECTRICAL CONNECTIONS.**

### 4.3 Initial Operation

Run the pump for two minutes in the correct rotation. Stop the pump and check for correct oil level in the sight glass. Add oil if necessary. The pump is shipped with oil in the gear case. **DO NOT OPEN THE FILLER PORT WHILE THE PUMP IS RUNNING.**

**WARNING!**

**Pumps that have reached operating temperature may have a high surface temperature on the top of the exhaust muffler.**

**DO NOT TOUCH!**

### 4.4 General Operation

**WARNING!**

**NEVER RUN THE PUMP WITHOUT LUBRICATING OIL!**

#### 4.4.1 Electrical Control Panel

The Medical Vacuum's **multiplex** control panel includes a visual and audible lag pump alarm and a 0-30"Hg vacuum gauge. It also has the following for **each pump**: 120V control transformer with fuses, hour meter, vacuum control switch, high discharge air temperature switch with alarm, high vacuum switch, with alarm, illuminated Hand-Off-Auto switch, motor starter and circuit breaker. All components are enclosed in a NEMA 12 enclosure.

## 4.4 General Operation (Continued)

### 4.4.1 Electrical Control Panel (Continued)

During normal operation, all H-O-A switches should be turned to the “Auto” position so that the PLC can effectively control the system. The PLC monitors the condition of the vacuum transducer, starts and stops the pumps depending on changing vacuum level and minimum run time values, and automatically alternates the lead position between units.

In a typical **duplex** system, one pump will be able to handle the system load. The PLC will signal the lead pump to start when pump’s vacuum level reaches the cut-in set point. If the one pump can carry the load, then the vacuum level will rise to the vacuum set point. At this point, if the minimum run timer for that pump has been satisfied, the PLC will turn off the lead pump. If the minimum run timer for that pump has not been satisfied, the lead pump will continue to run until the timer expires. When the system vacuum drops again, the PLC will automatically sequence the lead role to the other pump and will start it. If the lead pump runs continuously in lead for more than the adjustable minimum run time, the PLC will automatically sequence the pump attempting to evenly distribute the run time among all available pumps. If during operation, the second pump is required to come on in addition to the lead pump, the PLC will turn on the “Lag Alarm” (see section 4.5).

In a **triplex** or **quadruplex** system, the operation is very similar to the duplex operation described above with the following differences. With a triplex or a quadruplex system, the lag unit running alarm may not necessarily correspond to the third or fourth pump coming on. To determine when the PLC turns on the lag alarm, it counts the number of units in the “Auto” position and makes a decision based on the vacuum transducer conditions. For instance, in a quadruplex system with only 2 H-O-A switches in the “Auto” position, the lag alarm will turn on when the second unit is started.

On the **initial** system start-up, when the system vacuum level is below the set points of the vacuum transducer, the first pump will start. After a time delay, the next pump will start if required. The time delay is to prevent high inrush current after a power failure or emergency power switch over. During this initial system start-up, the lag alarm could come on at this point and is normal. It can be reset once the vacuum level has reached the transducer’s set point and the lag pump has cut off after it’s minimum run time has expired.



## **4.0 System Operation (Continued)**

### **4.4.1 Electrical Control Panel (Continued)**

#### **4.4.2 Minimum Run Timer(s)**

All vacuum systems incorporate minimum run timers to minimize the starts and stops on the vacuum pumps. The timers are adjustable and can be adjusted to suit the load of the hospital.

### **4.5 Tank Drain**

The standard tank drain consists of a manually operated ball valve.

To drain the liquid from the tank, open the tank bypass valve and close the tank isolation valves. Then open the drain valve. When draining is complete, close the drain valve first, then open the tank isolation valves and close the tank bypass valve.

### **4.6 Emergency Shutdown / Alarms**

The following conditions may arise during operation.

**Motor Overload Shutdown** - This will shut down the pump in question and will not re-start until the reset button on the starter inside the main control cabinet is reset. See Section 4 for troubleshooting information.

**High Discharge Air Temperature Shutdown** - This will shut down the vacuum pump in question and will not restart until the appropriate red push button is pressed on the main control panel. Before allowing the unit to re-start, the condition should be checked. Even after pushing the button, the unit may not re-start, depending on system sequencing and system vacuum.

**VFD Fault** -This will disable the VFD and the system will run in a non-VFD mode. The pump in question should be checked before restarting. A lag alarm will occur in this condition.

## 4.0 System Operation (Continued)

### 4.6 Emergency Shutdown / Alarms (Continued)

**Lag Unit Running Alarm** - This alarm will activate if the last available vacuum pump comes on. In the case of a duplex system, it will activate when the second pump turns on. In the case of a multiplex system, the lag alarm will activate when the last available unit is required to come on. For example, in a quadruplex system, if all four (4) H-O-A switches are set to “Auto”, then the lag alarm will trigger when the fourth unit comes on. If on the same system, three (3) of the four (4) H-O-A switches are set to “Auto” and the other to “Off” or “Hand”, then the lag alarm will activate when the third unit comes on. To silence the alarm, press the alarm reset button. In the event the lag alarm is persistent, check to see if any leaks or valves are open downstream or reduce the system load.

### 4.7 Relief Valve

The pump is built with an integral vacuum relief valve. The purpose of this relief valve is to prevent the pump from operating at a vacuum level that is too high. The maximum operating point varies by model and is factory set before shipping.

The function of the relief is very important to the successful long-term operation of the vacuum system. Since these pumps have no oil or water to carry away the heat of compression, an adequate flow of air *through* the pump, as well as air circulation *around* the pump, is vital.

**NEVER SET THE VACUUM RELIEF VALVE AT A POINT THAT  
EXCEEDS THE FACTORY RECOMMENDED LEVELS!**

### 5.0 Troubleshooting

Problem	Possible Causes	Solution
Failure to start	Main power disconnected	Turn on main power
	Power failure	Restore power
	Main fuse blown	Replace fuse
	Fuse blown in control circuit	Replace fuse
	Overload tripped on starter	Reset & check for system overload
	High temperature switch activated	Allow unit to cool; reset switch & check for over temperature condition
Power failure	Main fuse blown	Replace fuse
	Fuse blown in control circuit	Replace fuse
Unit lacks sufficient vacuum or lag alarm has occurred	Clogged Filters	Clean filters
	Vacuum relief valves need adjusting	Re-calibrate relief valve
	Restrictions in piping	Open pipe connections and examine for internal contamination or buildup
	Leaks in piping	Tighten all piping connections
	Insufficient pump speed (RPM)	Check voltage and amperage to motor  Inspect motor and coupling halves  Check that the pump shaft turns freely

**5.0 Troubleshooting (Continued)**

<b>Problem</b>	<b>Possible Causes</b>	<b>Solution</b>
Unit lacks sufficient vacuum or lag alarm has occurred	Line losses too high	Piping diameter too small replace with larger diameter pipe
	Unit is operating at an elevated altitude	Contact the factory for assistance. Performance may be reduced when operating well above sea level.
Motor breakers trip constantly	Defective motor	Test motor and replace if necessary
	Heaters incorrectly adjusted too small, or defective	Adjust or replace with correctly sized heaters
	Low motor voltage	Check at motor terminals. Contact electric service provider.
	Ambient temperature too high	Reduce ambient temperature
Unit runs rough and cannot be rotated manually	Worn Coupling	Remove motor and inspect coupling element. Replace if necessary.
	Worn bearings	Contact factory for assistance
Pump overheats	Cooling ducts blocked	Clean cooling ducts
	Cooling fan broken	Replace fan
	High ambient temperature	Ventilate or cool room
	Vacuum too high	Adjust vacuum settings or relief valve

### 5.0 Troubleshooting (Continued)

Problem	Possible Causes	Solution
Pump overheats	<p>Inlet restricted</p> <p>Exhaust restricted</p> <p>The oil tank may be low/empty of oil, has contaminated oil or was filled with an incorrect type of oil</p>	<p>Remove restriction</p> <p>Remove restriction</p> <p>If the oil level is found to be low, immediately shut off the pump, drain the remaining oil from the tank and replenish with fresh oil. If an incorrect oil type or contamination is found, make sure the pump has reached its operating temperature before replacing with fresh oil.</p>
High vacuum level	Vacuum relief valves need adjusting	Re-calibrate relief valve
Excessive noise level	<p>The coupling rubbers may be worn</p> <p>Internal pump damage</p>	<p>See “worn coupling” above</p> <p>Call factory for assistance</p>

For any operational problems not listed here, please contact your local **Patton’s Medical Service** representative.

**1-866-960-0087**

**6.0 Maintenance**

**6.1 Maintenance Schedule**

**WARNING:**  
**BEFORE STARTING ANY MAINTENANCE PROCEDURES,**  
**DISCONNECT ALL POWER TO THE PACKAGE.**

**WARNING:**  
**PUMPS THAT HAVE REACHED NORMAL OPERATING**  
**TEMPERATURE MAY HAVE A HIGH SURFACE TEMPERATURE OF MORE**  
**THAN 70°C (158°F).**  
**DO NOT PERFORM ANY MAINTENANCE UNTIL AFTER A**  
**SUFFICIENT COOL DOWN PERIOD.**

**Never perform any maintenance functions while the unit is in operation.**

**Maintenance Schedule**

Item	Frequency	Action
Exhaust drip leg	Daily	Check for accumulated moisture
Check inlet air filter(s)	Annually	Replace elements
Check electrical enclosure filters	Weekly initially, Monthly afterwards	Clean or Replace
Check electrical enclosure cooling fan for operation	Monthly	Replace if needed
Synchronizing Gear Oil Level	Weekly	Top off when pump is off
Check nuts, bolts, fittings, etc.	Monthly	Inspect and tighten
Synchronizing Gear Oil	Weekly 5,000 hours/Annually	Check oil Change oil
Pump Bearings 2-8.7 hp 15 hp	Not Required 6 months	Not required Grease B side bearings
Motor Coupling	Annually	Remove motor to inspect coupling for wear. Replace as needed.

## 6.0 Maintenance (Continued)

### 6.2 General Maintenance for All Units

#### Pumps

Maintain the pump regularly to achieve the best operating results. Maintenance intervals will depend on the pump's use and ambient conditions. Each pump has oil-lubricated synchronizing gears but there is no lubricant in the pumping chamber.

**Do not run pumps without synchronizing gear lubricating oil.**

#### Oil Type

The basic specification for the recommended oil is **non-detergent**. The viscosity must correspond to ISO-VG 220.

The recommended oil is Patton's # 43-01-004 for **Standard units**

The recommended oil is Patton's # 43-01-017 for **Oxygen safe units**

Please contact **Patton's Medical** for more information.

**Note:** If changing brands, it is important to completely drain out all oil from the pump.

#### Changing Synchronizing Gear Oil

Check the oil level regularly by observing the built-in sight glass. Each pump requires the proper oil to operate correctly. The oil should be changed every 5,000 hours of operation or more frequently when operating at ambient temperatures of 104°F.

To Change the oil:

1. Make sure the vacuum pump is shut down and locked against inadvertent start up.
2. Prior to draining the oil, always depressurize the gearbox by removing the oil fill plug, located on top of the gear box.
3. Place a drain tray underneath the drain plug and drain the oil.
4. Firmly reinsert the drain plug in the drain valve.
5. Fill with new gear oil until the level is slightly above the middle of the sight glass.
6. Dispose of the used oil in compliance with applicable regulations.

Oil Quantity per Vacuum Pump	
System	Oil Quantity (liters)
2 hp	.85
3 hp	.85
4 hp	.85
5.4 hp	.85
6.4 hp	1
7.5 hp	1
8.7 hp	1
10 hp	1
15 hp	.63

**6.0 Maintenance (Continued)**

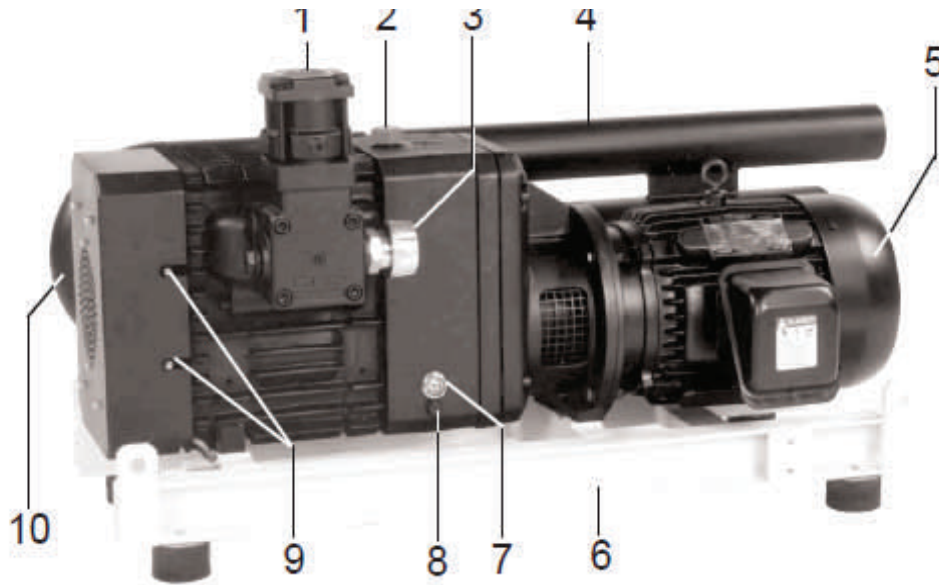

- |                     |                   |                   |
|---------------------|-------------------|-------------------|
| 1 Inlet             | 5 Motor           | 9 Grease fittings |
| 2 Oil fill          | 6 Frame           | 10 Cooling fan    |
| 3 Vac. relief valve | 7 Oil sight glass |                   |
| 4 Silencer          | 8 Oil drain plug  |                   |

6.2

**“B-side” Bearing Lubrication (Standard Claw)**

The “B-side” bearings of the Standard 15 HP vacuum unit needs to be greased twice a year with the high melting-point grease, Kluber Asonic HQ 72-102. **Patton’s # 43-02-007**  
Grease can be added to the bearings by charging the bearings with grease through the grease fittings (9) until grease comes out of the opening.

**“B-side” Bearing Lubrication (Oxygen Safe Claw)**

The “B-side” bearings of the Oxygen Safe 15 HP vacuum unit needs to be greased twice a year with Oxygen Safe Grease **Patton’s # 43-02-014**  
Cover plates will need to be removed to add grease to the bearings.

**Pump Fan/Motor Fan Openings**

Periodically inspect the pump for accumulation of debris and dirt. Keep the ventilation grills of the motor fan and the pump fan clear of excessive debris. Overheating of the pump or motor could result if these openings are blocked.



## Inlet Filters

The inlet filter elements should be checked monthly initially. If filter elements are dirty replace with new elements. Elements should be replaced yearly or after 4000 hrs of operation..

## Exhaust Drip Leg Valve

Each pump should have a drip leg installed by others at the exhaust port on the pump. This valve should be checked daily at first, then depending on the moisture accumulated could be checked less frequently.

### **WARNING:**

**BEFORE STARTING ANY MAINTENANCE PROCEDURES,  
DISCONNECT ALL POWER TO THE PACKAGE.**

## 7.0 Inspection/Replacement Procedures

### 7.1 Air Intake Filter

**Never perform any maintenance functions while the unit is in operation.**

The air intake filter element should be changed every 4,000 hours of operation or annually under normal operating conditions. To change the filter:

1. Turn off the vacuum pump being serviced and lock open the appropriate disconnect switches.
2. Close intake isolation valve
3. Remove the protective cover by loosening the latches.
4. Remove the element.
5. Clean inside of housing.
6. Insert a new element (note orientation of the element).
7. Replace protective cover and tighten wing nut (if applicable) and latches.
8. Open intake isolation valve
9. Turn on the vacuum pump.

### 7.2 Enclosure Fan Filter Element

The enclosure filter element should be checked weekly initially and monthly or as needed afterwards.

1. Remove bottom louvered cover on left side of control panel.
2. Remove filter element from filter housing.
3. Clean filter with mild detergent using warm water.
4. Dry filter element and replace.



**Note: No filter element is required in upper louvered housing.**



## Oil-Less Rotary Claw Medical Vacuum System

### 8.0 Replacement Parts

Any information, service or spare parts requests should include the machine serial number and be directed to:

**Patton's Medical**  
3201 South Boulevard  
Charlotte, NC 28209

Telephone: 1-866-960-0087  
Fax: (704) 525-5148

[Medical.service@pattonsmmedical.com](mailto:Medical.service@pattonsmmedical.com)  
[www.pattonsmmedical.com](http://www.pattonsmmedical.com)

#### Duplex System Parts

Description	2 - 3 HP	Qty per System
Inlet Filter Element	09-11-011	2
Oil "Standard Claw" (1 Quart)	43-01-004	2
Oil "Oxygen Safe Claw" (1 Pint)	43-01-017	4

Description	4 - 5.4 HP	Qty per System
Inlet Filter Element	09-11-006	2
Oil "Standard Claw" (1 Quart)	43-01-004	2
Oil "Oxygen Safe Claw" (1 Pint)	43-01-017	4

Description	6.4 - 10 HP	Qty per System
Inlet Filter Element	09-11-007	2
Oil "Standard Claw" (1 Quart)	43-01-004	2
Oil "Oxygen Safe Claw" (1 Pint)	43-01-017	4

Description	15 HP	Qty per System
Inlet Filter Element	09-11-012	2
Oil "Standard Claw" (1 Quart)	43-01-004	2
Oil "Oxygen Safe Claw" (1 Pint)	43-01-017	4

### 8.0 Replacement Parts (Continued)

#### Triplex System Parts

Description	5.4 HP	Qty per System
Inlet Filter Element	09-11-006	3
Oil "Standard Claw" (1 Quart)	43-01-004	3
Oil "Oxygen Safe Claw" (1 Pint)	43-01-017	6
Description	6.4 - 10 HP	Qty per System
Inlet Filter Element	09-11-007	3
Oil "Standard Claw" (1 Quart)	43-01-004	3
Oil "Oxygen Safe Claw" (1 Pint)	43-01-017	6
Description	15 HP	Qty per System
Inlet Filter Element	09-11-012	3
Oil "Standard Claw" (1 Quart)	43-01-004	3
Oil "Oxygen Safe Claw" (1 Pint)	43-01-017	6

#### Quadruplex System Parts

Description	5.4 HP	Qty per System
Inlet Filter Element	09-11-006	4
Oil "Standard Claw" (1 Quart)	43-01-004	4
Oil "Oxygen Safe Claw" (1 Pint)	43-01-017	8
Description	6.4 - 10 HP	Qty per System
Inlet Filter Element	09-11-007	4
Oil "Standard Claw" (1 Quart)	43-01-004	4
Oil "Oxygen Safe Claw" (1 Pint)	43-01-017	8
Description	15 HP	Qty per System
Inlet Filter Element	09-11-012	4
Oil "Standard Claw" (1 Quart)	43-01-004	4
Oil "Oxygen Safe Claw" (1 Pint)	43-01-017	8

**8.0 Replacement Parts (Continued)****Common Parts**

Description	Part Number	Qty. / Pump	Qty. / System
<b>All Systems</b>			
Vacuum Transducer	30-07-025		1
Back up Vacuum Switch	30-07-001		1

## 9.0 Warranty

### Medical Vacuum System Warranty

**Patton's Medical** warrants the total Medical Vacuum system to be free of defects in material and workmanship under normal use for a period of twenty-four months from start-up, not to exceed thirty months from date of shipment. This warranty covers all necessary parts used in repair as well as all reasonable labor expense. Normal consumable parts required for routine scheduled maintenance (such as filters) are not covered under this warranty.

This warranty does not apply to products that are damaged by external causes, or are improperly warehoused, used, installed, serviced, misapplied or maintained by the customer. The sole liability for **Patton's Medical** under this warranty is limited to repairing, replacing, or crediting, at its election, any such products provided that:

- **Patton's Medical** is notified promptly within the warranty period above of any warranty claim.
- The examination of such items by an authorized representative of **Patton's Medical** will disclose to their reasonable satisfaction that claimed products defect has not been caused by misuse, neglect, improper handling, installation, repair, alteration, or accidents.
- **Patton's Medical** requires that all equipment be commissioned by an authorized **Patton's Medical** distributor and requires a start-up report to be filed within 30 days of equipment start-up. Failure to submit a start-up report to **Patton's Medical** will void the warranty.
- Simplex units 5Hp and below do not include factory assisted start-up in their base price unless specifically noted otherwise. Failure to submit a start-up report to Patton's Medical will void the warranty.

Product modification performed by the customer without prior written approval by **Patton's Medical** will invalidate the above warranty.

**This warranty is given in lieu of all other warranties, expressed or implied, including implied warranties of fitness for a particular purpose and merchantability. In no event shall Patton's Medical be liable for damages in excess of the value of the defective product or part, nor shall Patton's Medical be liable for any indirect, special or consequential damages, loss of profits of any kind, or for loss of use of the products.**

**Patton's Medical** shall not be liable to the customer for any claims, loss of damage of any kind whatsoever arising from the nonperformance of **Patton's Medical** of any part of this agreement occasioned by acts of God, fire, war, labor difficulties, governmental regulations, or action of government. **Patton's Medical** shall not be liable to the customer for any other cause, whether of a similar or dissimilar nature beyond its reasonable control.



*Oil-Less Rotary Claw Medical Vacuum System*

**10.0 Maintenance Record**

**Model Number**

**Serial Number**

**Installation Date**

**Notes:**

<b>Date of Service</b>					
<b>Hours</b>					
<b>Load</b>					
<b>Ambient Temp.</b>					
<b>Inlet Filter</b>					
<b>Misc.</b>					
<b>Serviced By:</b>					



## *Oil-Less Rotary Claw Medical Vacuum System*

### **10.0 Maintenance Record**

**Model Number**

**Serial Number**

**Installation Date**

**Notes:**

<b>Date of Service</b>					
<b>Hours</b>					
<b>Load</b>					
<b>Ambient Temp.</b>					
<b>Inlet Filter</b>					
<b>Misc.</b>					
<b>Serviced By:</b>					



*Oil-Less Rotary Claw Medical Vacuum System*

**10.0 Maintenance Record**

**Model Number**

**Serial Number**

**Installation Date**

**Notes:**

<b>Date of Service</b>					
<b>Hours</b>					
<b>Load</b>					
<b>Ambient Temp.</b>					
<b>Inlet Filter</b>					
<b>Misc.</b>					
<b>Serviced By:</b>					





## *Oil-Less Rotary Claw Medical Vacuum System*

### **10.0 Maintenance Record**

**Model Number**

**Serial Number**

**Installation Date**

**Notes:**

<b>Date of Service</b>					
<b>Hours</b>					
<b>Load</b>					
<b>Ambient Temp.</b>					
<b>Inlet Filter</b>					
<b>Misc.</b>					
<b>Serviced By:</b>					



3201 South Boulevard  
Charlotte, NC 28209  
1-866-960-0087  
[www.pattonsmmedical.com](http://www.pattonsmmedical.com)