

**NFPA 99 Compliant Duplex “Oil-Less” Claw Medical Vacuum Package  
3 HP Vertical Tank Mounted (Fixed Speed or VFD )**

**Vacuum Package**

- Fully compliant with the latest edition of NFPA 99
- Two oil-less rotary claw type vacuum pumps with inlet filter and isolation valve for each
- ASME coded vacuum receiver with bypass and manual drain
- Duplex control panel with automatic lead/lag controls
- All components completely pre-piped and pre-wired to single point service connections
- Vibration isolation mountings
- Liquid tight conduit, fittings and junction boxes for all control and power wiring
- All interconnecting piping and wiring is completed and operationally tested prior to shipment

**Vacuum Pump**

- Oil-less rotary claw pump
- Direct-driven through a shaft coupling
- Air-cooled
- End (ultimate) vacuum = 28" Hg (at sea level)
- Dry-running, with two claw-type, non-contacting rotors
- Sealing fluid not required
- Virtually maintenance-free operation
- High discharge temperature switch
- Oil change required at approximately 5,000 operating hour intervals in the gearbox only
- Built-in, anti-suck-back valve mounted at the pump inlet

**Vacuum Motor**

- NEMA rated
- C-face
- TEFC
- 208 or 230/460V 3-phase

**Vibration Isolation System**

- Vacuum and motor - fully isolated from the package base by means of a four-point, heavy duty, isolation system
- Minimum of 95% isolation efficiency
- Optional seismically restrained isolators at an additional cost

**Intake/Discharge Piping**

- Vacuum pumps are connected to a common manifold and piped to a vertical receiver
- Inlet check valve on each pump
- Inlet isolation valve on each pump
- Flexible connectors between pumps and manifold
- Discharge flex connection shipped loose

**Vacuum Receiver**

- Vertical orientation with integrally mounted bypass
- ASME Code stamped
- National Board Certified
- Rated for a minimum 200 PSIG design pressure
- Vacuum gauge
- Manual drain

**Bacterial Filters**

- Compliant with NFPA 99:2018 Health Care Facilities Codes
- Particulate removal >99.995% efficiency
- Minimizes microbial contamination of vacuum pump, oil, and surrounding environment
- Glass drain flask for easy removal and sterilization
- Additional valve to release vacuum on filter cannister for service

**System Health**

- Monitoring and Trending of key components to provide notification of potential issue with the Health of the System
- Vacuum monitoring
- Current monitoring for each motor
- Ambient Temperature monitoring
- Trending of pumps running

**Control System**

- Mounted and wired duplex control system
- NEMA 12 and UL 508A labeled
- **74v only:** Variable frequency drive to control one pump at a time
- Automatic lead/lag sequencing
- Circuit breakers
  - **74:** One for each motor with external operators
  - **74v:** One external disconnect, but internally one for VFD and one for each motor
- Full voltage motor starters with overload protection
- 120V control circuit transformers for each motor circuit
- Visual and audible reserve unit alarm with isolated contacts for remote alarm
- Hand-off-auto selector switches for reliable back-up
- Automatic alternation of compressors based on a first-on/first-off principle with provisions for simultaneous operation
- Automatic activation of reserve unit if required
- Visual and audible alarm indication for high discharge air temperature shutdown with isolated contacts for remote alarm
- SIGNAL 1™ – touch screen gateway

Standard Screen Displays

- |                        |  |
|------------------------|--|
| + Air level/Runtime    | + Replacement parts                    |
| + Alarm history        | + Troubleshooting guidelines           |
| + Service Indicator    | + Historical trending of system status |
| + Maintenance Schedule | + System Health                        |

- 7" Wide TFT Graphic Touch Screen with Motion Actuated Backlit LED and Bright 65,536 (16-bit) Colors
- Downloadable Trend Information via USB Host Port or Network Device
- 128MB Flash Memory, 64MB DRAM
- Built-in Ethernet Port 10/100 Base-T (RJ45)
- Supports over 100 Communication Protocols including Ethernet IP, and Modbus TCP/IP
- Built-in VNC server allowing remote monitoring of live graphics through standard browser, smart phones & mobile devices
- Share data between HMI and Building Management systems

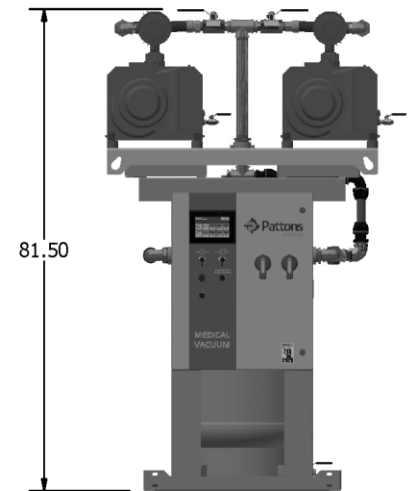
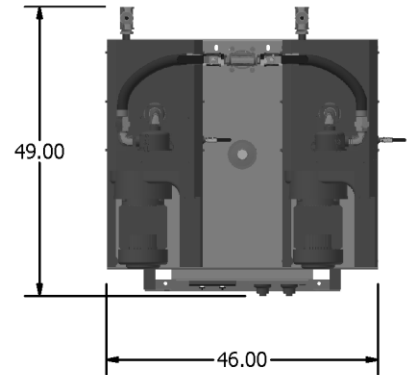
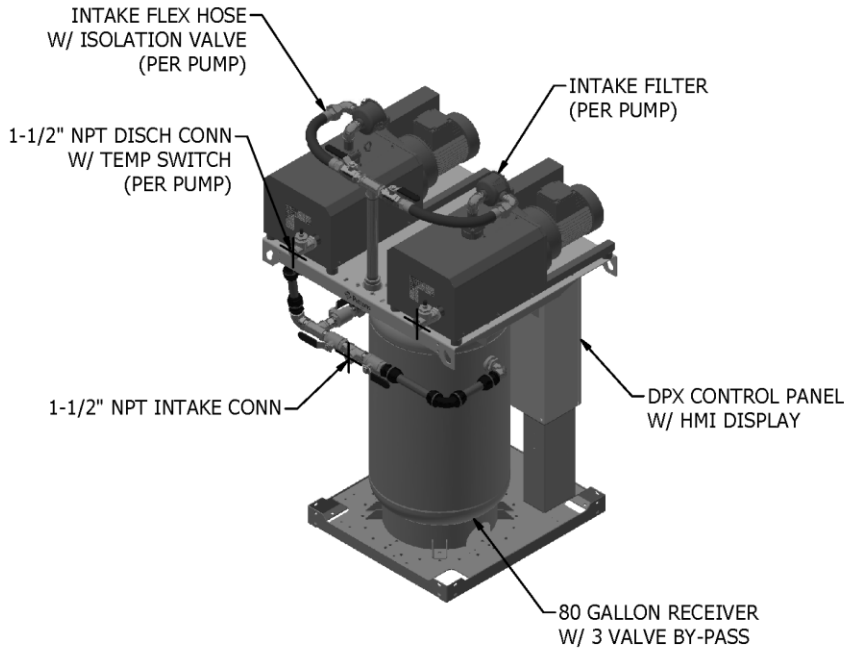

Duplex Claw Medical Vacuum Package Specification										
Model Number	HP	Capacity @19" Hg <sup>2</sup>		Package BTU/HR <sup>3</sup>	Noise Level <sup>4</sup>	System FLA			Receiver Size (gallons)	Package Weight (pounds)
		Pump (SCFM)	System (SCFM)			208V (A)	230 (B)	460 V (C)		
74I-22-032(A/B/C)	3	21	21	7,650	70	21	20	9	80	1,470
74Iv-22-032(A/B/C)										1,520

**Notes:**

- <sup>1</sup> Normal Operating conditions at a maximum ambient of 105° F. Consult factory for higher ambient conditions.
- <sup>2</sup> Capacities are shown per NFPA 99 standard with one pump in reserve.
- <sup>3</sup> Package BTU/HR are shown with one pump in reserve.
- <sup>4</sup> Noise levels are shown in dB(A) with the reserve pump on standby.

**Statement of Warranty**

Patton's Medical warrants all Medical Air packages, to be free of defects in material and workmanship under normal use for a period not to exceed thirty (30) months from date of shipment, or twenty-four (24) months from date of start-up.